

# Rosa Pools







# Índice

	Pág.
<b>Introducción</b>	05
<b>01. Programa de colores</b>	20
<b>02. El borde</b>	
- El Sistema 9	34
- Sistemas desbordantes	36
- Sistema Skimmer	70
<b>03. El vaso</b>	78
<b>04. La playa</b>	88
<b>05. Vestuarios</b>	96
<b>06. Zonas comunitarias</b>	104
<b>07. Complementos</b>	116
<b>08. Información técnica</b>	118
<b>09. Sostenibilidad</b>	146

# Index

	Pg.
<b>Introduction</b>	05
<b>01. Color program</b>	20
<b>02. The edge</b>	
- System 9	34
- Deck level pool systems	36
- Skimmer System	70
<b>03. The tank</b>	78
<b>04. Pool decks</b>	88
<b>05. Changing rooms</b>	96
<b>06. Common areas</b>	104
<b>07. Accessories</b>	116
<b>08. Technical information</b>	118
<b>09. Sustainability</b>	146

# Sommaire

	Pg.
<b>Introduction</b>	05
<b>01. Programme de couleurs</b>	20
<b>02. Le bord</b>	
- Le Système 9	34
- Systèmes à débordement	36
- Système Skimmer	70
<b>03. Le bassin</b>	78
<b>04. Plages</b>	88
<b>05. Vestiaires</b>	96
<b>06. Zones communes</b>	104
<b>07. Accessoires</b>	116
<b>08. Information technique</b>	118
<b>09. Durabilité</b>	146







## Soluciones únicas para piscinas únicas

Más de 40 años de experiencia en el sector piscina y miles de proyectos en todo el mundo son la clave de nuestra especialización: **fabricar soluciones de gres porcelánico para facilitar el diseño y la construcción de piscinas de principio a fin.**

**Soluciones completas.** Imprescindibles porque ayudan en todo el proceso creativo y constructivo: el diseño y la arquitectura, elegir el sistema constructivo más adecuado o el producto de colocación perfecto.

**Soluciones para ofrecer un servicio excelente,** gracias a nuestro equipo técnico asesor enfocado en los profesionales de la arquitectura. Y nuestros recursos online con la nueva colección de **objetos BIM** ya disponible.

**Soluciones innovadoras** como las rejillas de gres porcelánico en más de 30 colores, Premio Architizer 2016, o nuestros **exclusivos acabados antideslizantes,** confortables y fáciles de limpiar.

**Soluciones flexibles y tan prácticas** que pueden aplicarse a todo tipo de proyectos: piscinas públicas, de competición, deportivas, de hotel, espacios Wellness y piscinas privadas.

**Soluciones de diseño.** Cuatro programas de colores de gres porcelánico y mosaico de alta calidad. Más de 70 tonos y texturas, diversidad de formatos y una gama específica de piezas especiales para piscinas.

**Soluciones constructivas.** El **Sistema 9** para el coronamiento y el **Sistema 10** que facilita la construcción completa del vaso de la piscina.

Diseñar soluciones es una misión apasionante. Implica descubrir, innovar, mejorar. Con este nuevo catálogo, **Rosa Pools,** nuestro objetivo es múltiple y a la vez único y emocionante: **que nuestras soluciones sean la mejor ayuda para realizar vuestros proyectos.**

## Unique solutions for unique pools

Over 40 years of experience in the pool industry and thousands of projects throughout the world are the keys to our specialization: **manufacturing porcelain stoneware solutions to facilitate the design and construction of swimming pools, from beginning to end.**

**Complete solutions** are essential since they support the entire creation and construction process: design and architecture, as well as choosing the most appropriate construction system and the perfect placement product.

**Solutions for offering an excellent service.** Thanks to our technical advisory team, which is specialized in advising architects; and our online resources, with the new collection of **BIM objects** now available.

**Innovative solutions,** such as our porcelain grids, available in over 30 colors and which won a 2016 Architizer Award; and our **exclusive anti-slip finishes,** comfortable and easy to clean.

**Flexible and practical solutions** that can be applied to any kind of swimming pool project: for competitions, sports, hotels, Wellness areas, public or private.

**Design solutions.** Four high-quality porcelain stoneware and mosaic color programs. Over 70 shades and textures, a diversity of formats and a specific range of pieces designed specifically for swimming pools.

**Constructive solutions.** **System 9** for coping and **System 10** for facilitating the overall construction of the pool tank.

Designing solutions is a fascinating mission. It involves discovering, innovating and improving. With this new catalog, **Rosa Pools,** our goal is not only diverse but also unique and exciting: **for our solutions to provide the best help when carrying out your projects.**

## Des solutions uniques pour des piscines uniques

Plus de 40 ans d'expérience dans le secteur des piscines et des milliers de projets à travers le monde sont la clé de notre spécialisation: **fabriquer des solutions en grès cérame pour faciliter la conception et la construction de piscines du début à la fin.**

**Solutions complètes.** Incontournables, car elles facilitent le processus créatif et constructif: la conception et l'architecture, le choix du système constructif le plus adapté ou le produit adhésif idéal.

**Solutions pour vous offrir un excellent service.** Grâce à notre équipe technique de consultants travaillant avec des professionnels de l'architecture et à nos ressources en ligne, comme la nouvelle collection d'**objets BIM** déjà disponible.

**Solutions innovantes** comme les grilles en grès cérame, plus de 30 couleurs, ayant reçu le prix Architizer 2016 ou nos **finitions antidérapantes exclusives,** confortables et faciles à nettoyer.

**Solutions flexibles et pratiques** applicables à toutes sortes de projets: piscines publiques, de compétition, sportives, d'hôtel, espaces Wellness et piscines privées.

**Solutions de conception.** Quatre programmes de couleurs de grès cérame et mosaïque de grande qualité. Plus de 70 tons et textures, une diversité des formats et une gamme spécifique de pièces spéciales pour piscines.

**Solutions de construction.** Le **Système 9** pour le couronnement et le **Système 10** qui facilite la construction complète du bassin de la piscine.

Concevoir des solutions est une mission passionnante: découvrir, innover, améliorer. Avec ce nouveau catalogue **Rosa Pools,** notre objectif est multiple, unique et palpitant: **que nos solutions constituent la meilleure aide possible pour réaliser vos projets.**

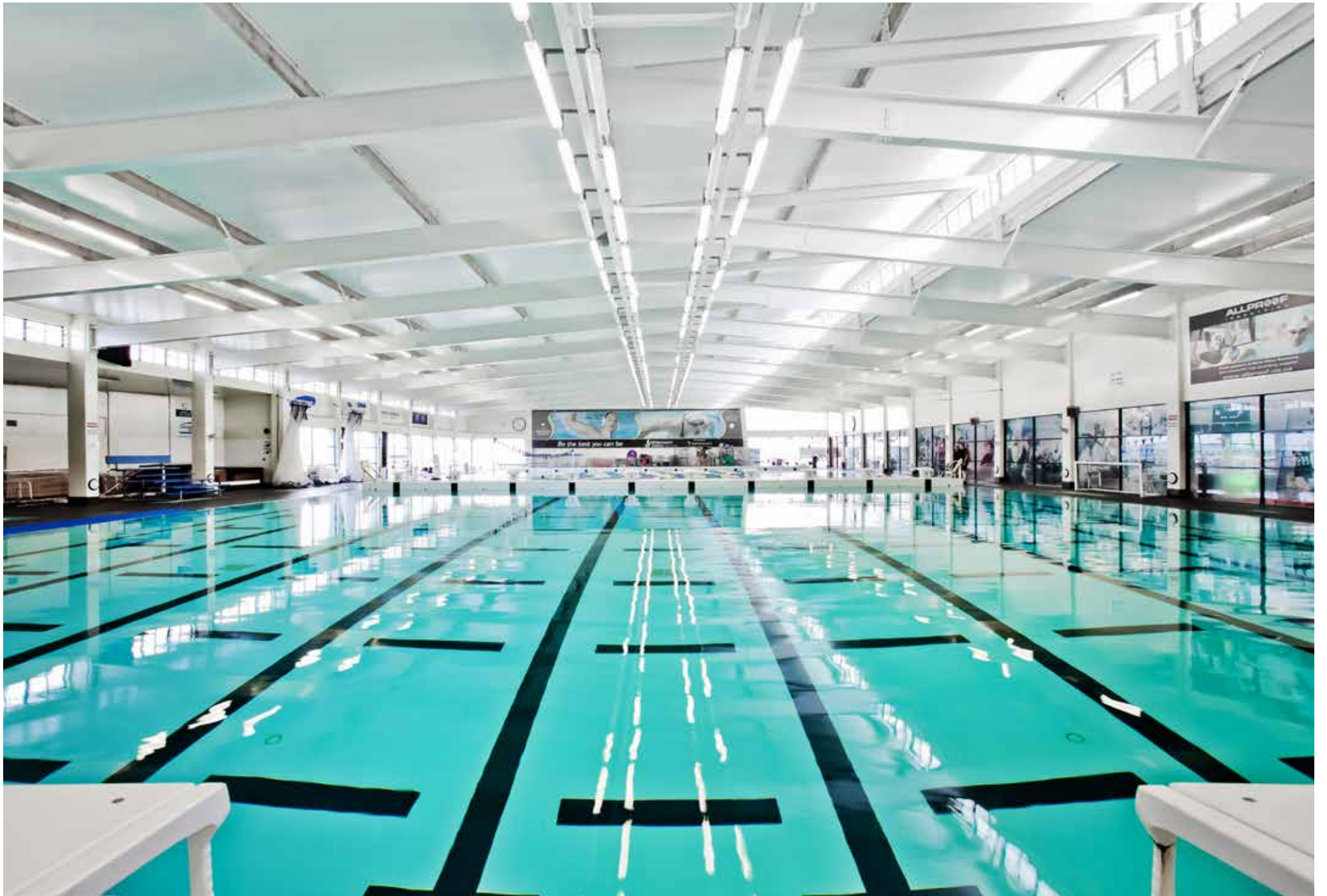



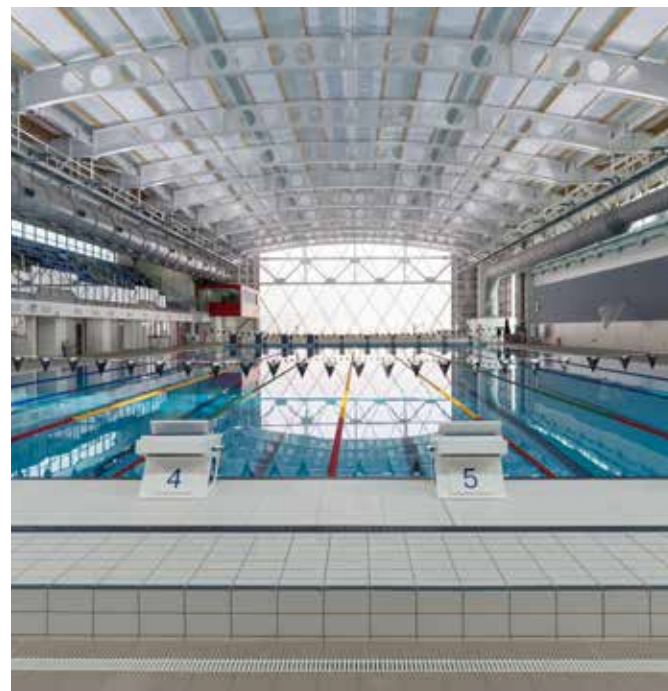

**Sir Owen G. Glenn National Aquatic Center,  
Auckland, New Zealand**

Piscina Olímpica - Olympic Pool - Piscine Olympique  
**Ergo System / Blanco**







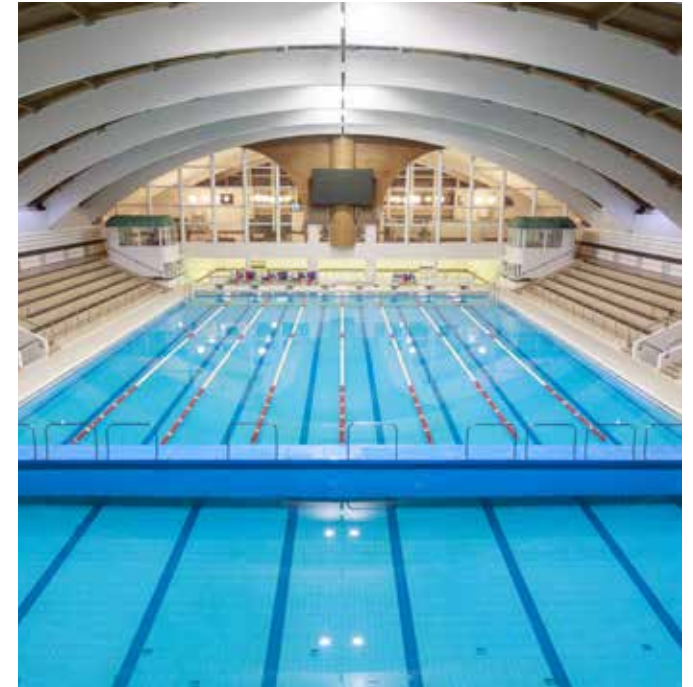

**Nyeki Imre Swimming Center,  
Budapest, Hungary**

Piscina interior - Indoor Pool - Piscine intérieure  
**Finlandés Finnish Finlandais System / Azul**









**Hotel Pure Salt Adriano, Mallorca, Spain**

Arquitecto - Architect - Architecte

**Giuseppe Violante, Zanobia Arquitectura**

Piscina exterior - Outdoor pool - Piscine extérieure

**Vintage Bone**



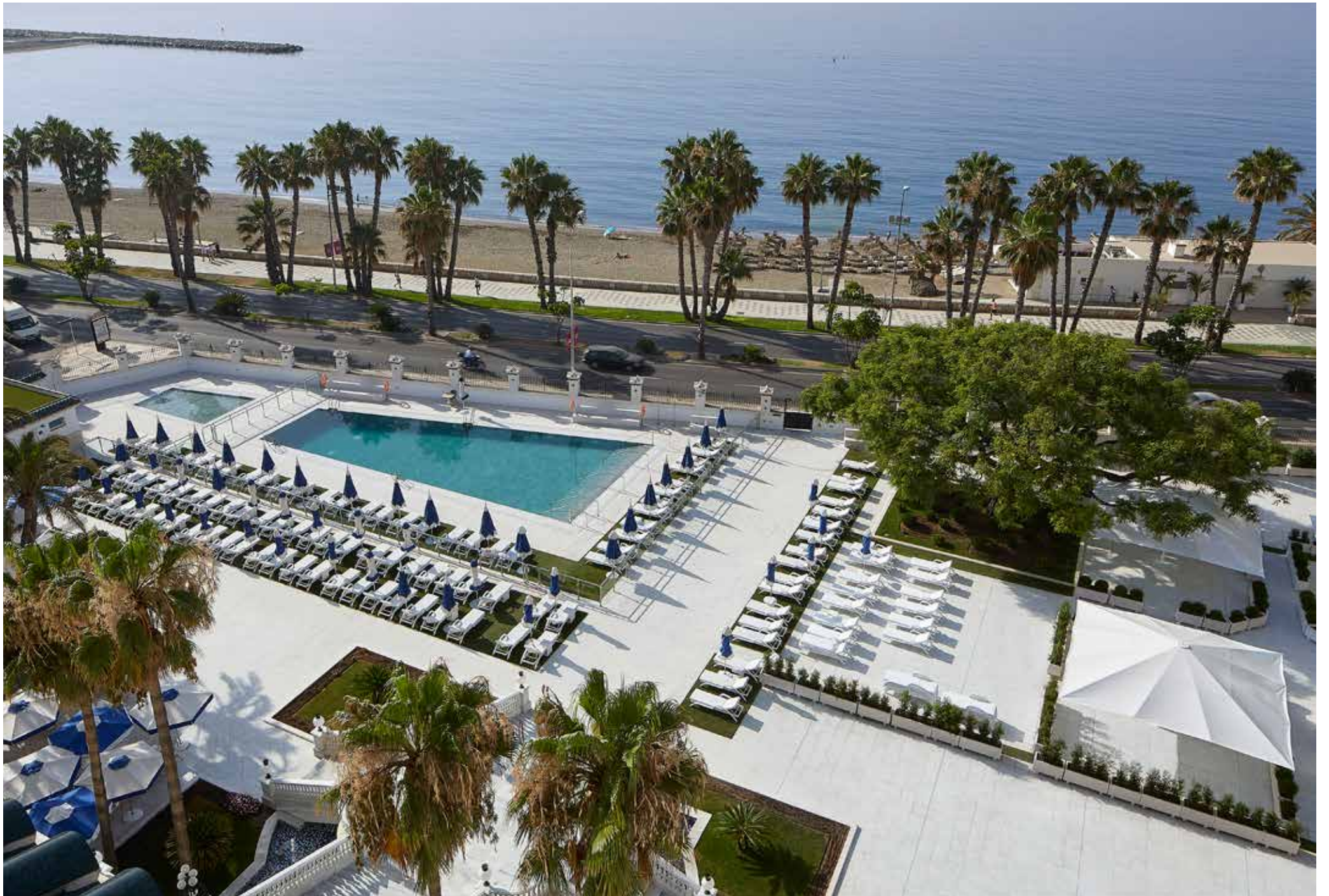





## **Gran Hotel Miramar, Málaga, Spain**

Arquitecto - Architect - Architecte  
**Roberto Duarte**

Piscina exterior - Outdoor pool - Piscine extérieure  
**Prestige System / Serena Bianco**

Terrazas - Outdoor terraces - Terrasses  
**Serena Bianco**

Chill - out area  
**Serena Bianco**

Spa  
**Prestige System / Serena Ocra**



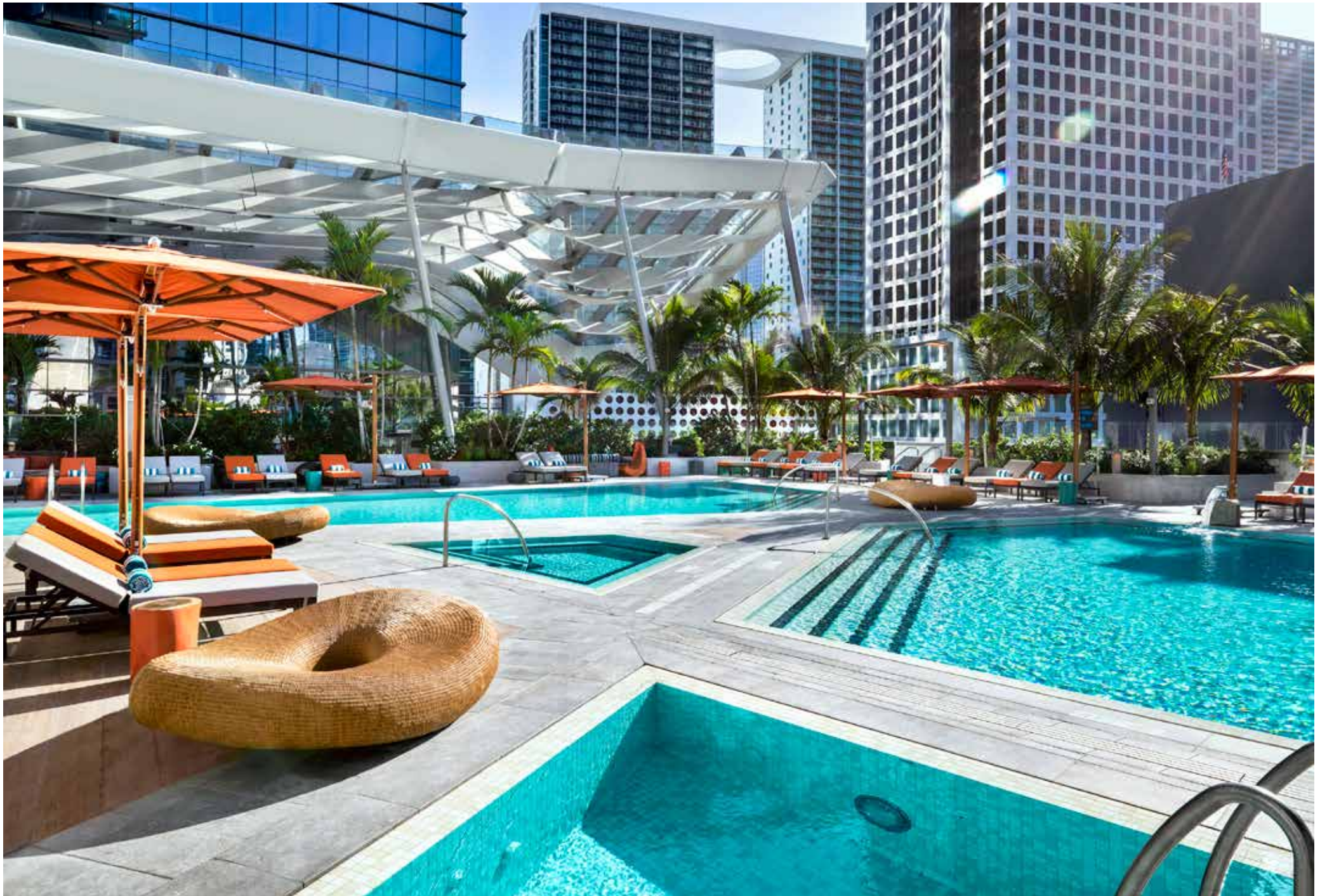



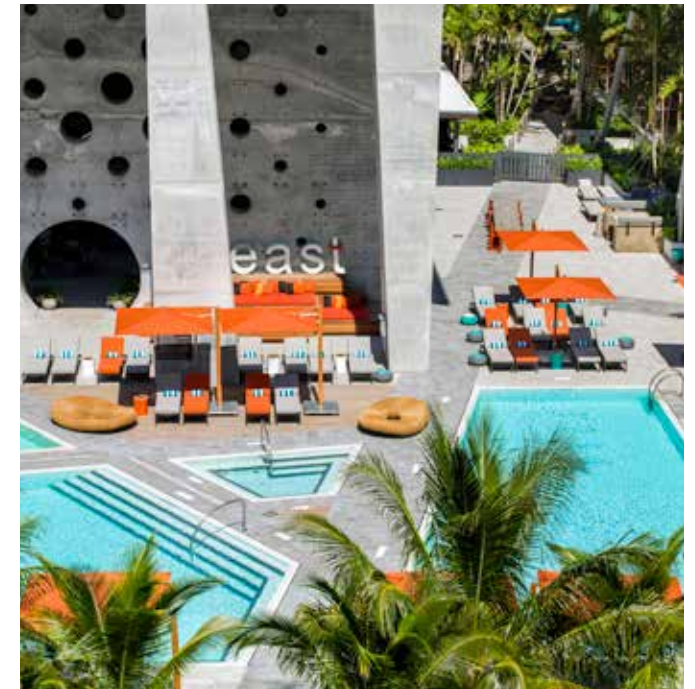
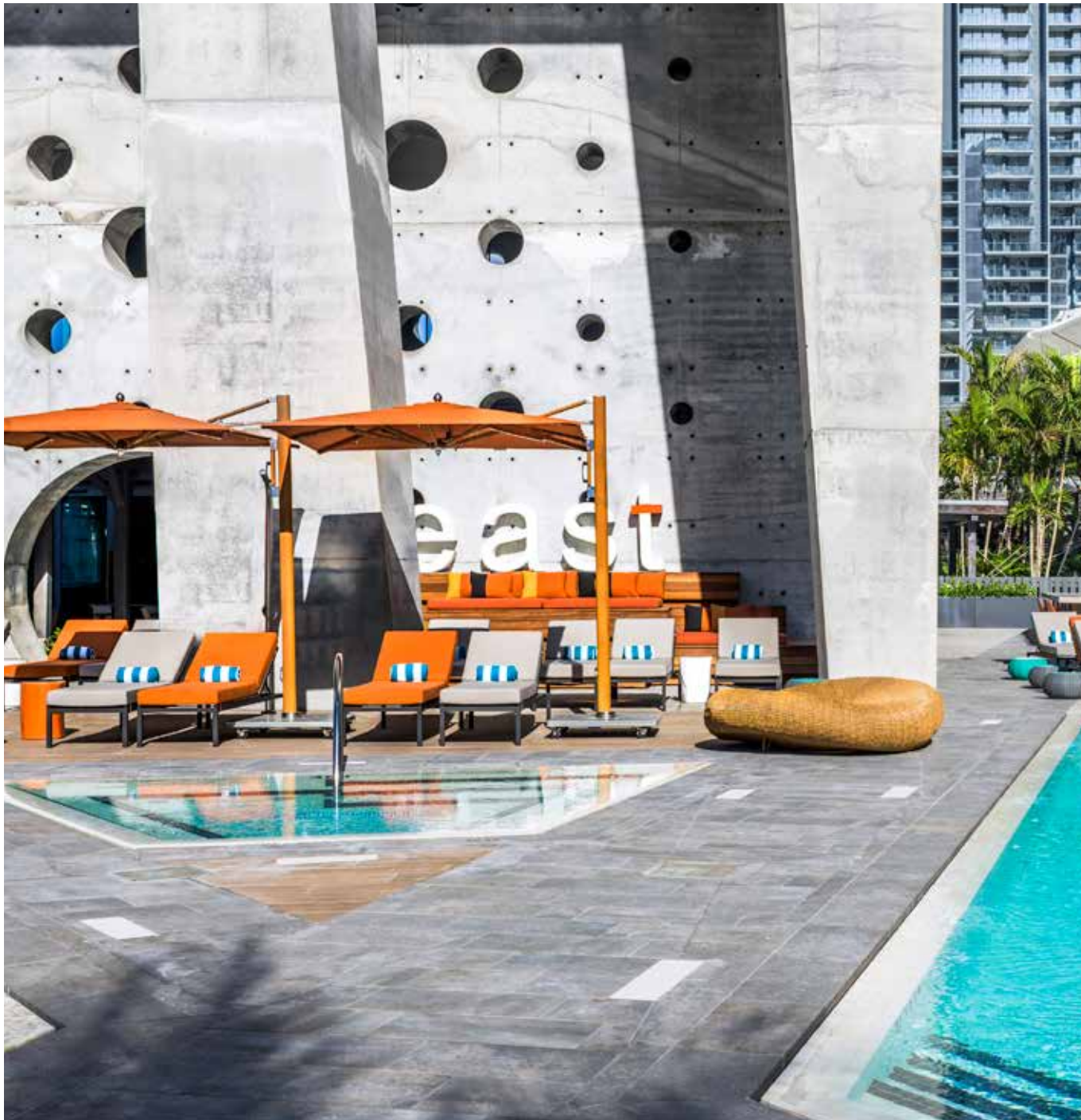

## **EAST, Miami, USA**

Arquitecto - Architect - Architecte

**Arquitectonica**

Piscina exterior - Outdoor pool - Piscine extérieure

**Mistry Blue Stone**









**Spa Hotel Hilton Saint Petersburg, Russia**

Arquitecto - Architect - Architecte  
**KSK GROUP**

Piscina elevada - Raised edge pool - Piscine surélevée  
**Mistry Grey**







### **Private Pool, Tuscany, Italy**

Arquitecto - Architect - Architecte  
**BG Italia S.R.L.**

Piscina exterior - Outdoor pool - Piscine extérieure  
**Prestige System / Mistery Sand**



## metro



## mosaic

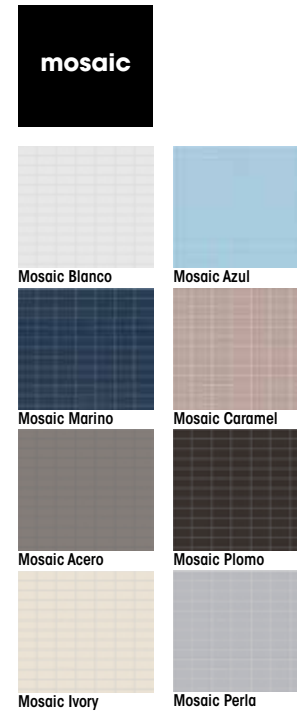

## project





perfectly  
imperfect



## i'perfect

serena		bohème		mistery	tao	vintage	lovely	garden		natural 2.0

Los 4 programas de colores **Rosa Pools** están estructurados según **tipología de producto, gama cromática, estilo y formatos**.

The 4 color programs by **Rosa Pools** are structured according to **product type, color range, style and format**.

Les 4 programmes de couleurs **Rosa Pools** sont structurés selon la **typologie de produit, la gamme chromatique, le style et les formats**.

### ACABADOS / FINISHES / FINITIONS

**Liso:** Smooth / Lisse

**Anti-Slip:** Antideslizante / Anti-slip / Anti-dérapant

**Abujardado:** Bush hammered / Bouchardé

**Pastilla:** Grid surface / Structuré



SHADE VARIATIONS





244 G1  
liso / anti-slip  
24,4 x 49,4 x 0,8



122 G1  
liso / anti-slip  
11,9 x 24,4 x 0,8



052 G1  
liso  
5,6 x 24,4 x 0,8



Blanco



Azul

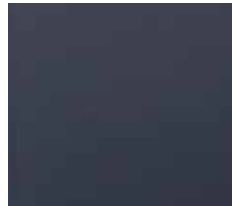

Marino



Caramel



Acero

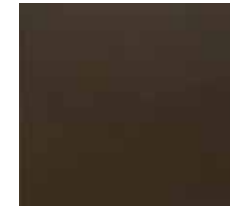

Plomo

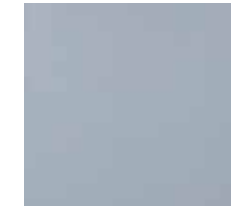

Ultramar



Prusia



Esmeralda



Habana



Lima



Oliva



Amarillo

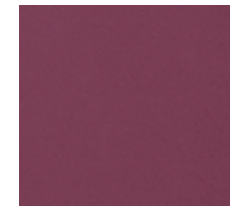

Violet



Orange



Rojo N



240 G1  
pastilla  
24,4 x 24,4 x 0,8

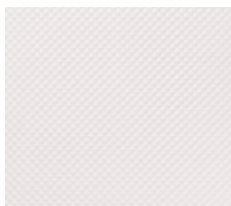

Blanco Pastilla



Marino Pastilla



Acero Pastilla

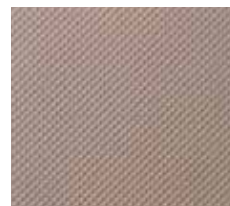

Caramel Pastilla

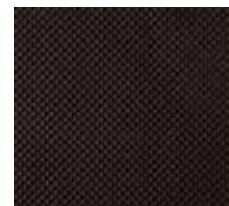

Plomo Pastilla

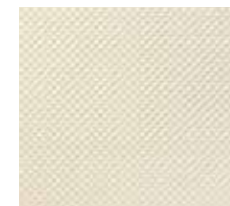

Indubeige Pastilla





### Indugres



**122 G3**  
R9 - R10 - R11- R12  
11,9 x 24,4 x 1

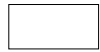

**122 G5**  
R10 - R11- R12  
11,9 x 24,4 x 1,4



**122 G6**  
R10 - R11  
11,9 x 24,4 x 1,8



**240 G3**  
R9 - R10 - R11- R12  
24,4 x 24,4 x 1



**Indubeige**

**R9** 11,9 x 24,4 x 1  
**R10** 11,9 x 24,4 x 1  
**R11** 11,9 x 24,4 x 1  
**R12** 11,9 x 24,4 x 1  
**R10** 11,9 x 24,4 x 1,4  
**R11** 11,9 x 24,4 x 1,4  
**R12** 11,9 x 24,4 x 1,4  
**R10** 11,9 x 24,4 x 1,8  
**R11** 11,9 x 24,4 x 1,8  
**R9** 24,4 x 24,4 x 1  
**R10** 24,4 x 24,4 x 1  
**R11** 24,4 x 24,4 x 1  
**R12** 24,4 x 24,4 x 1



**Indu Tech**

**R10** 24,4 x 24,4 x 1  
**R12** 24,4 x 24,4 x 1



**Indu Grey**

**R10** 24,4 x 24,4 x 1  
**R12** 24,4 x 24,4 x 1



### Biostop



**244 G1**  
liso  
24,4 x 49,4 x 0,8



**240 G1**  
pastilla  
24,4 x 24,4 x 0,8



**240 G3**  
R10 - R11- R12  
24,4 x 24,4 x 1



**122 G5**  
R10 - R11  
11,9 x 24,4 x 1,4

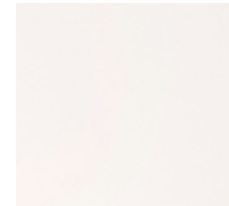

**Bio - White**

24,4 x 49,4 x 0,8

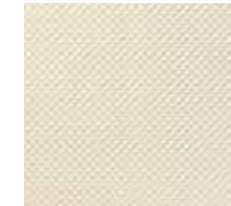

**Biobeige Pastilla**

24,4 x 24,4 x 0,8

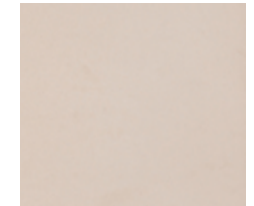

**Biobeige**

**R10** 11,9 x 24,4 x 1,4  
**R11** 11,9 x 24,4 x 1,4  
**R10** 24,4 x 24,4 x 1  
**R11** 24,4 x 24,4 x 1  
**R12** 24,4 x 24,4 x 1



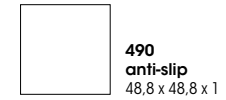
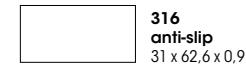
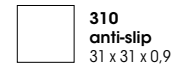

Serena Bianco



Serena Ocra



Serena Griggio



Serena Nero

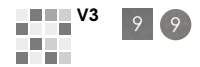

Gran Hotel Miramar, Málaga, Spain. Roberto Duarte Architect  
Serena Bianco



Private pool  
Serena Ocra, Serena Mix



Serena Mix

(1) Solo Ref. 316 (31 x 62,6 x 0,9)

(1) Ref. 316 only (31 x 62,6 x 0,9)

(1) Seulement Ref. 316 (31 x 62,6 x 0,9)

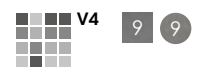





**310**  
anti-slip  
31 x 31 x 0,9

**316**  
liso / anti-slip  
31 x 62,6 x 0,9

**490**  
liso / anti-slip  
48,8 x 48,8 x 1



Bohème Vanille



Bohème Brune



Bohème Glacé



Bohème Nuit



Private pool  
Bohème Brune



Piezas decoradas / Decor pieces / Pièces décorées  
Bohème Glacé

Color de junta recomendado  
Recommended grout joint color  
Couleur de joint recommandé

 **EUROCOLOR FLEX**

 **CERPOXI / PROFESSIONAL PX**





**310**  
anti-slip  
31 x 31 x 0,9

**316**  
liso / anti-slip  
31 x 62,6 x 0,9

**487**  
liso / anti-slip  
48,8 x 79,2 x 1

**490 G6**  
anti-slip  
48,8 x 48,8 x 1,8



Mistry White



Mistry Sand



Mistry Grey

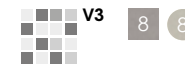

Mistry Blue Stone



Private pool / Josep Aurell, GAAB Arquitectes  
Mistry White



Private pool  
Mistry White / Mistry Grey



Hotel Pure Salt Garonda, Palma de Mallorca, Spain / Giuseppe Violante, Zanobia Arquitectura  
Mistry Blue Stone



310  
anti-slip  
31 x 31 x 0,9

316  
liso / anti-slip  
31 x 62,6 x 0,9

487  
liso / anti-slip  
48,8 x 79,2 x 1



Tao Beige



Tao Brown



Tao Silver



Tao Grey



Private terrace  
Tao Brown



Hotel Meliá Costa del Sol, Málaga, Spain  
Tao Grey





310  
anti-slip  
31 x 31 x 0,9

316  
liso / anti-slip  
31 x 62,6 x 0,9

487  
liso / anti-slip  
48,8 x 79,2 x 1



Vintage Bone



Vintage Land



Vintage Brick

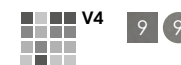

Vintage Bronze



Hotel Casa Vilella, Sitges, Spain / Alfonso Morales Comella Architect  
Vintage Land





157  
liso / anti-slip  
15,25 x 78,25 x 1



Lovely Snow



Lovely Soft



Lovely Dolce



Lovely Smoke



Hotel Casas del Lago, Ciutadella, Spain / Roberto Duarte Architect  
Lovely Dolce



Lovely Vital



Lovely Intense

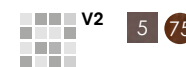

Lovely Dark







240  
anti-slip  
24,4 x 24,4 x 1

122  
anti-slip  
11,9 x 24,4 x 1



Garden Blanco



Garden Rojo



Garden Moka



Private pool  
Garden Blanco



Private terrace  
Garden Rojo



310  
anti-slip  
31 x 31 x 0,9



Private terrace  
Natural 2.0 Hierro



Natural 2.0 Palma



Natural 2.0 Hierro



Private terrace  
Natural 2.0 Palma





300  
abujardado  
29,8 x 29,8 x 1

306  
liso / abujardado  
29,8 x 59,8 x 1

600  
liso / abujardado  
59,8 x 59,8 x 1



**Proyecta Petra**



**Proyecta Arena**



**Proyecta Perla**



**Proyecta Selenio**



Hotel Lani's Suites Deluxe, Lanzarote, Spain  
*Proyecta Petra*



**Proyecta Onix**



**320**  
 liso / anti-slip  
 33 x 33 x 0,5  
 2,3 x 2,3 / u

**323**  
 liso / anti-slip  
 33 x 33 x 0,5  
 2,3 x 4,6 / u

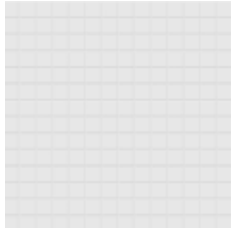

Ref. 320  
 Mosaic Blanco

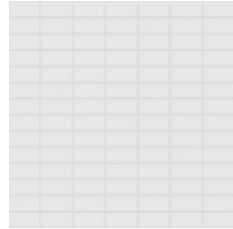

Ref. 323  
 Mosaic Blanco

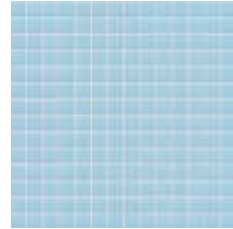

Ref. 320  
 Mosaic Azul



Ref. 323  
 Mosaic Azul

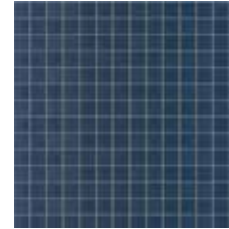

Ref. 320  
 Mosaic Marino

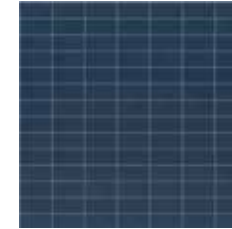

Ref. 323  
 Mosaic Marino

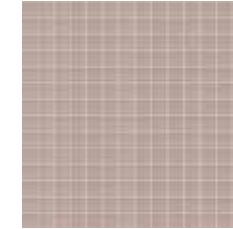

Ref. 320  
 Mosaic Caramel

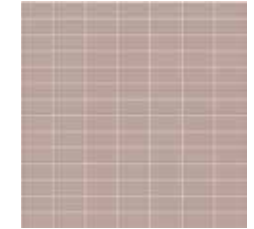

Ref. 323  
 Mosaic Caramel

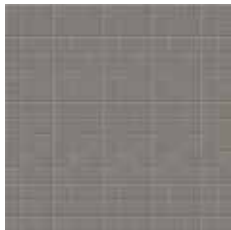

Ref. 320  
 Mosaic Acero

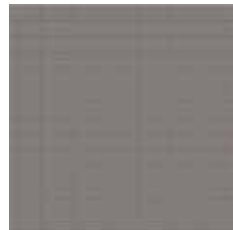

Ref. 323  
 Mosaic Acero

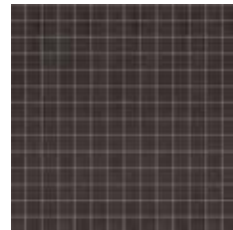

Ref. 320  
 Mosaic Plomo

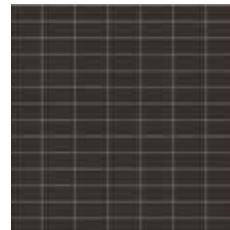

Ref. 323  
 Mosaic Plomo



Ref. 320  
 Mosaic Ivory

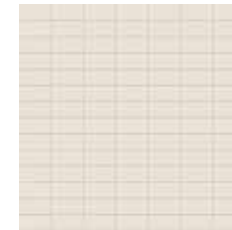

Ref. 323  
 Mosaic Ivory

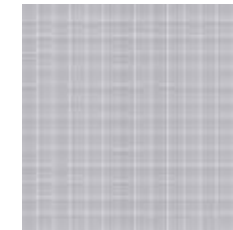

Ref. 320  
 Mosaic Perla

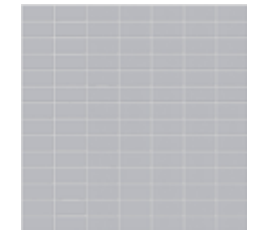

Ref. 323  
 Mosaic Perla



## Sistema 9, el coronamiento prefabricado para piscinas desbordantes patentado por Rosa Gres

El **Sistema 9** consiste en un coronamiento prefabricado formado por bloques de hormigón hidrófugo. Cada pieza funciona como canal y soporte de la cerámica.

El **Sistema 9** mejora la construcción de piscinas de playa desbordante tanto públicas como privadas.

## System 9, the prefabricated coping for deck level pools patented by Rosa Gres

**System 9** consists in a prefabricated coping made of waterproof concrete blocks. Each piece functions as both a channel and a support for the ceramic.

**System 9** improves the construction of deck level pools, both public and private.

## Système 9, couronnement préfabriqué pour les piscines à débordement, breveté par Rosa Gres

Le **Système 9** consiste en un couronnement préfabriqué composé d'un ensemble de blocs de béton hydrofuge. Chacune des pièces sert de goulotte et de support à la céramique.

Le **Système 9** améliore la construction des piscines à débordement, publiques comme privées.



**S9 Horyzon**



**S9 Finlandés**  
**S9 Finnish**  
**S9 Finlandais**

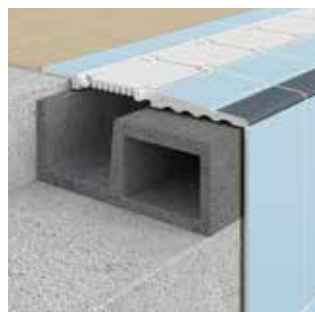

**S9 Ergo**



**S9 Wiesbaden**



**S9 Spa**



**S9 Prestige**

## Las ventajas del Sistema 9

### MAYOR AGILIDAD

Se perfecciona el proceso de instalación reduciendo tiempo, mano de obra y recursos económicos y energéticos.

### MENOR DIFICULTAD

Las piezas han sido diseñadas para optimizar su colocación y facilitar la construcción.

### ACABADO MÁS EFICIENTE

Mejora el acabado superior del muro de hormigón gunitado alargando la vida de la edificación.

### MAYOR PRECISIÓN

Elimina las deficiencias producidas por el encofrado.

### EXCELENTE ACABADO

El resultado final es un rebose de agua perfecto, mayor higiene, menor necesidad de utilizar productos para la depuración y reducción de la pérdida de agua.

### AUMENTO DE LA ESTÉTICA

El perímetro de la piscina es más bello, rectilíneo y homogéneo.

### ES MÁS SOSTENIBLE

Favorece la edificación sostenible gracias a la reducción de recursos energéticos.

## The advantages of System 9

### MORE AGILITY

The installation process has been perfected to reduce time, labor, economic and energetic resources.

### LESS DIFFICULTY

The pieces have been designed to optimize their placement and make the construction process easier.

### MORE EFFICIENT FINISH

It improves the upper finish of the Gunit concrete wall, increasing the life of the edification.

### HIGHER PRECISION

Eliminates the deficiencies produced by the formwork.

### EXCELLENT FINISH

The final result is a perfect water overflow, more hygiene, less need to use purification products and less water loss.

### BETTER ESTHETIC OUTCOME

The pool's perimeter is more beautiful, rectilinear and homogenous.

### MORE SUSTAINABLE

It favors sustainable building thanks to the reduction of energy resources.

## Les avantages du Système 9

### AGILITÉ ACCRUE

Le processus d'installation s'en trouve perfectionné: diminution du temps employé, de la main d'œuvre, des ressources financières et énergétiques.

### MOINDRE DIFFICULTÉ

Les pièces sont conçues pour optimiser leur mise en place et rendre la construction plus facile.

### UNE FINITION PLUS EFFICACE

Il améliore la finition de la surface en béton gunité, pour une durée de vie du bâti plus longue.

### DAVANTAGE DE PRÉCISION

Il élimine les défauts générés par le coffrage.

### FINITION PARFAITE

Le résultat final est une goulotte parfaite et une plus grande hygiène. Le gaspillage d'eau est réduit et on utilise moins de produits d'épuration d'eau.

### UNE ESTHÉTIQUE SUBLIMÉE POUR ENCORE PLUS DE BIEN-ÊTRE

Le périmètre de la piscine, rectiligne et homogène, est encore plus beau.

### DÉVELOPPEMENT DURABLE

La construction est plus durable grâce à la diminution des ressources énergétiques.

## El Sistema 10: La piscina prefabricada de hormigón

Más información en:  
[rosagres.com/sistema10](http://rosagres.com/sistema10)

## System 10: The precast swimming pool

More information at:  
[rosagres.com/en/system10](http://rosagres.com/en/system10)

## Le Système 10: La piscine préfabriquée en béton

Plus d'informations sur:  
[rosagres.com/fr/systeme10](http://rosagres.com/fr/systeme10)



discover!



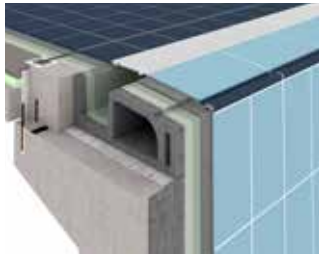

**Horyzon**



**Finlandés**  
Finnish  
Finlandais



**Ergo**



**Wiesbaden**

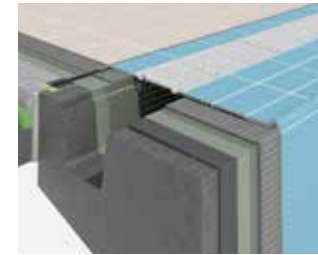

**Zurich**



**Spa**

## Metro



## Metro



## Mosaic

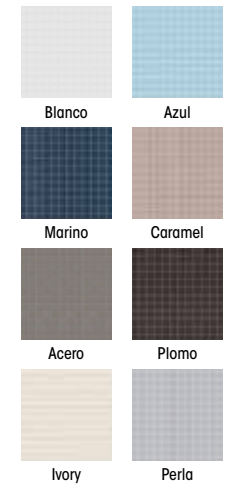

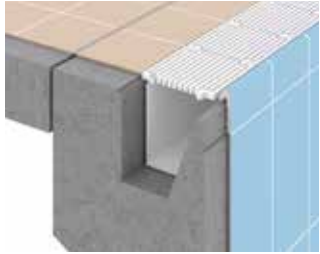

**Australia A**



**Australia B**

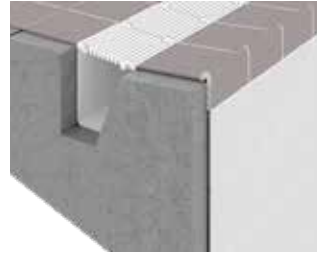

**Munich**



**Wiesbaden B**



**Prestige**  
con **Rejilla Compact**  
with **Compact Grid**  
avec **Grille Compact**



**Prestige**  
con **Rejilla Flex**  
with **Flex Grid**  
avec **Grille Flex**

## Metro



## i'perfect





Dos piezas cerámicas de gran formato que conforman una suave pendiente y facilitan el agarre del bañista.

Comprising 2 large format ceramic tiles that form a gentle slope and provide bathers a better grip.

Deux pièces céramiques de grand format qui forment une pente douce et facilitent l'adhérence de l'utilisateur.

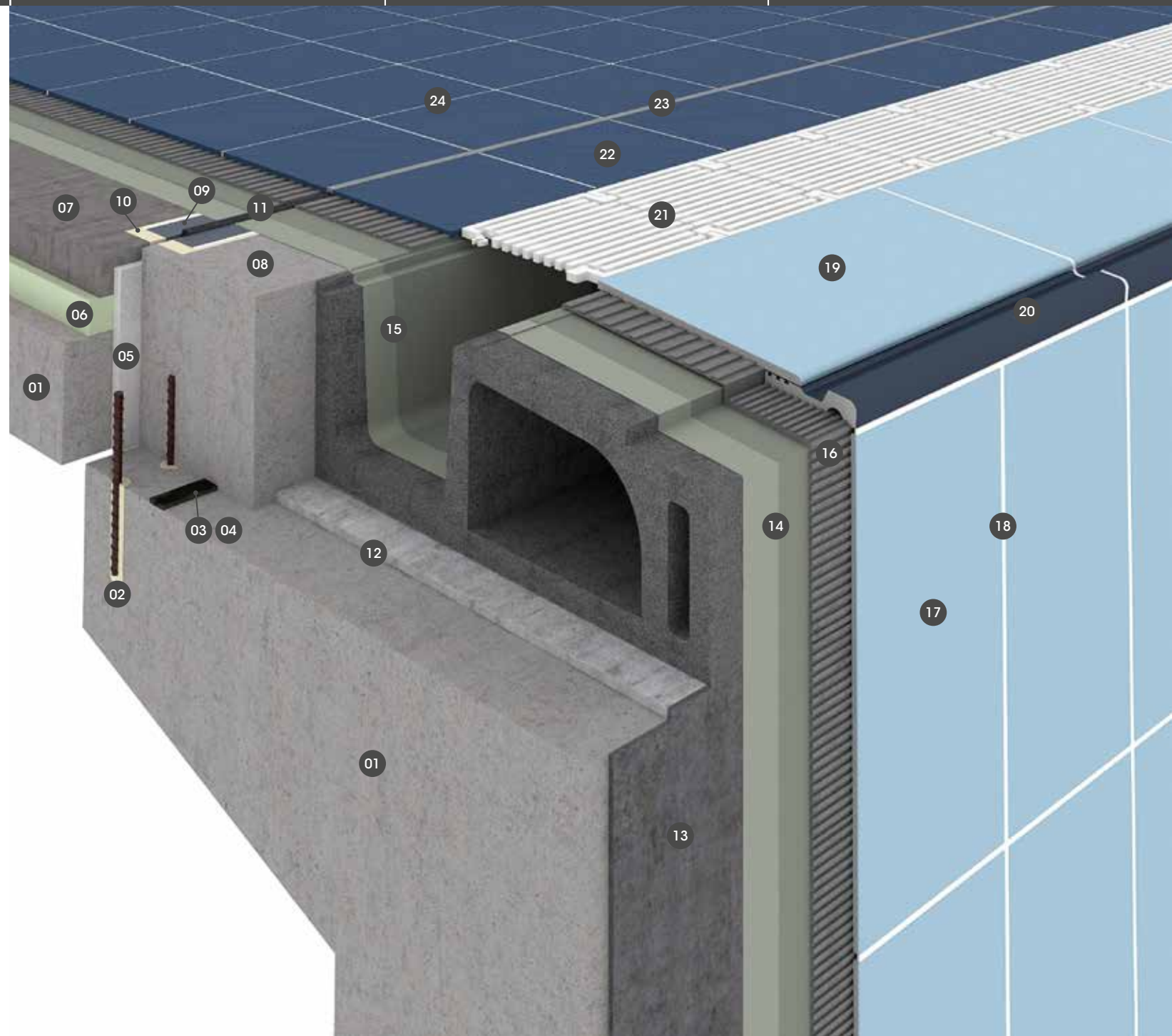

- 01 Estructura de hormigón del vaso  
Concrete structure of the tank  
Structure en béton de la piscine
- 02 **EPOXICOL**  
Mortero epoxi de anclaje  
Epoxy anchoring mortar  
Mortier époxy de calage
- 03 **FUGA-STOP MINI 20 x 10 mm**  
Junta hidro-expansiva  
Hydro-expanding waterstop  
Profilé d'étanchéité hydro-expansif
- 04 **MASTIC MS**  
Adhesivo para pegar la Fuga-Stop Mini  
Adhesive for sticking the Fuga-Stop Mini  
Adhésif pour coller le Fuga-Stop Mini
- 05 **POLIESTIRENO EXPANDIDO:**  
relleno de la junta de dilatación  
**EXPANDED POLYSTYRENE:**  
filling of the expansion joint  
**POLYSTYRÈNE EXPANSÉ:**  
remplissage du joint de dilatation
- 06 **POLIESTIRENO EXTRUSIONADO:**  
aislamiento térmico  
**EXTRUDED POLYSTYRENE:**  
thermal insulation  
**POLYSTYRÈNE EXTRUDÉ:**  
isolation thermique
- 07 **PAVIFORT**  
Mortero de recrecido de las playas  
Pre-mixed mortar for screeds  
Mortier prêt à gâcher, pour la réalisation de chapes
- 08 Talón de hormigón posterior a las piezas S9  
Concrete wall behind the S9 pieces  
Mur de béton derrière les pièces S9
- 09 **FIX-TAPE 170 mm**  
Junta de dilatación elástica e impermeable  
Elastic and waterproof strip for expansion joints  
Bande élastique et imperméable pour les joints de dilatation
- 10 **EPOXICOL**  
Mortero epoxi adhesivo de la Fix-tape 170 mm  
Epoxy adhesive mortar for Fix-tape 170 mm  
Mortier-colle époxy pour Fix-tape 170 mm
- 11 **SELLALASTIC FOAM**  
Cordón elástico de relleno de la junta  
Closed cell to use as background filling in joints  
Profilé en polyéthylène à cellule fermée utilisée comme fond de joint
- 12 Mortero adhesivo de las piezas de S9 mejorado con Primfix  
Improved adhesive mortar with Primfix to fix S9 pieces  
Mortier amélioré avec Primfix pour fixer les pièces S9
- 13 **FIX-REVOCO**  
Mortero adhesivo para recrecido de paredes  
Pre-mixed adhesive mortar for rendering walls  
Mortier prêt à gâcher, pour la réalisation de crépissages sur murs
- 14 **HIDROELASTIC**  
1ª y 2ª mano de la impermeabilización elástica  
1st and 2nd layer of elastic waterproofing  
1<sup>ère</sup> et 2<sup>ème</sup> couche d'imperméabilisation élastique
- 15 **HIDROFIX**  
1ª y 2ª mano de impermeabilización flexible  
1st and 2nd layer of flexible waterproofing  
1<sup>ère</sup> et 2<sup>ème</sup> couche d'imperméabilisation flexible
- 16 **TECNOCOL FLEX**  
Ultra-adhesivo para el pegado de la cerámica  
Maximum adherence glue-cement for sticking porcelain tiles  
Ciment colle flexible, à adhérence maximale pour la pose de grès cérame
- 17 **244 liso / anti-slip 24,4 x 49,4 cm Rosa Gres**  
Gres porcelánico  
Porcelain tile  
Grès cérame
- 18 **CERPOXI**  
Mortero de rejuntado epoxi anti-ácido  
100% impermeable  
Epoxy mortar, waterproof and acid proof for sealing joints.  
Époxy joint, extra fluide, imperméable et inattaquable par les acides
- 19 **R49 anti-slip 29,7 x 49,4 cm Rosa Gres**  
Gres porcelánico  
Porcelain tile  
Grès cérame
- 20 **G49 anti-slip 11,9 x 49,4 cm Rosa Gres**  
Gres porcelánico  
Porcelain tile  
Grès cérame
- 21 Rejilla de plástico  
Plastic grid  
Grille en plastique
- 22 **240 pastilla 24,4 x 24,4 cm Rosa Gres**  
Gres porcelánico  
Porcelain tile  
Grès cérame
- 23 **SELLALASTIC**  
Masilla de poliuretano de máxima elasticidad  
Polyurethane filler of extraordinary elasticity  
Mastic polyuréthane d'une extraordinaire élasticité.
- 24 **JUNTATEC**  
Mortero de rejuntado resistente a los ácidos débiles  
Mortar for sealing resistant to slight chemical aggressions  
Mortier pour le scellement de joint, résistant aux légères agressions chimiques



Community Pool, Santa Perpètua de Mogoda, Spain  
Blanco / Mystery Grey

Horyzon | Con S9 | With S9 | Avec S9

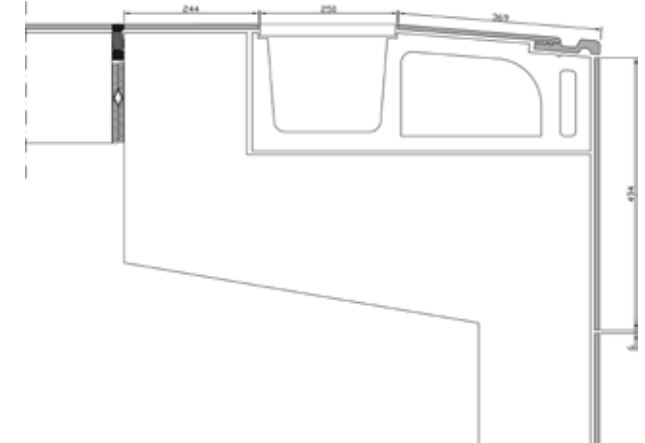

Horyzon | Sin S9 | Without S9 | Sans S9

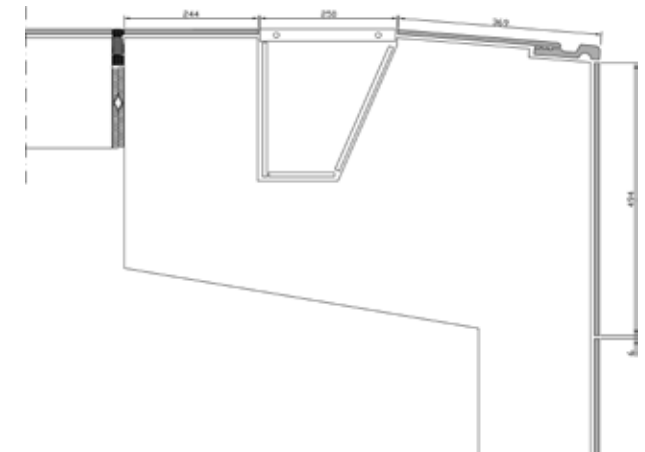



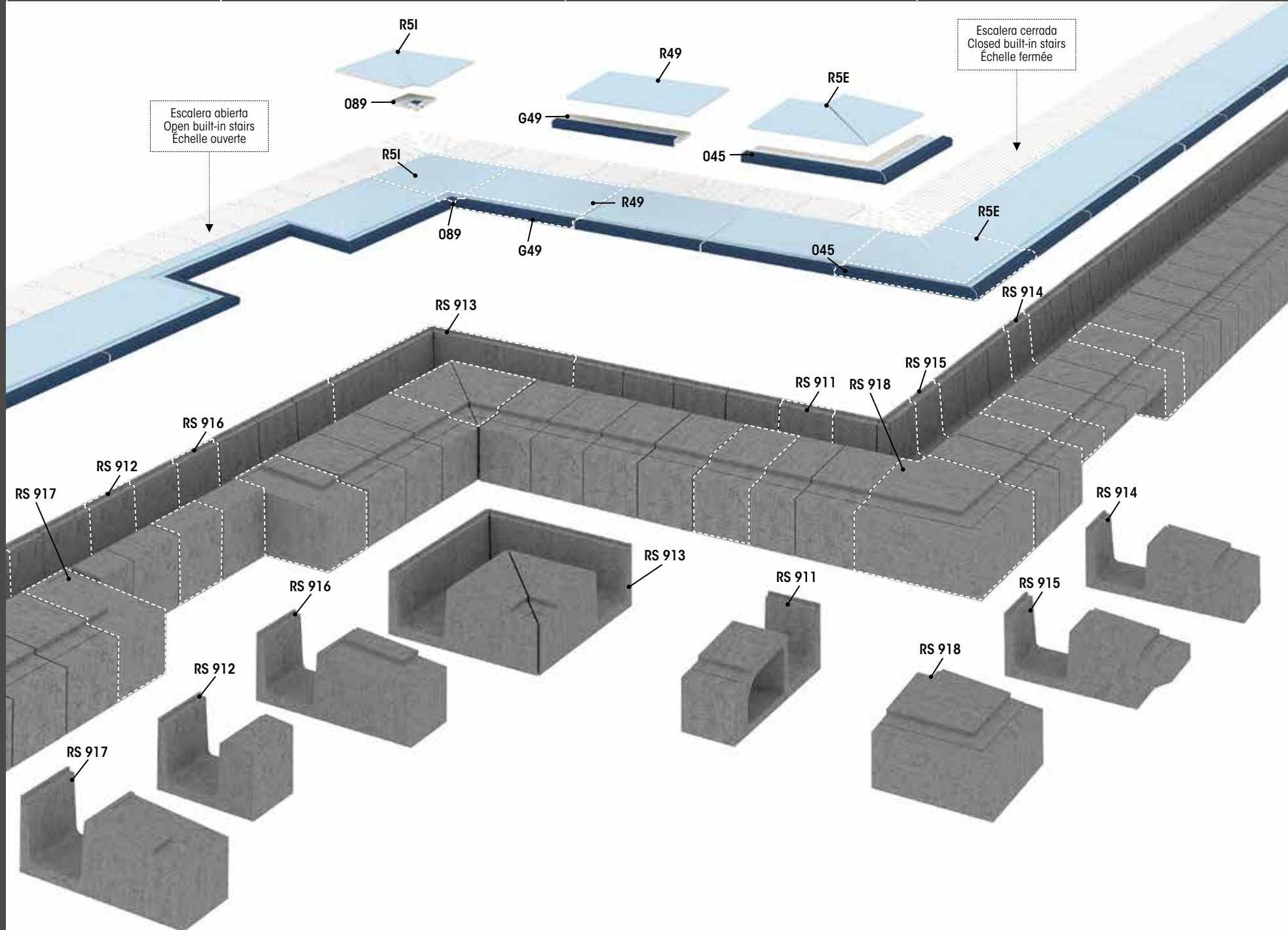

### Piezas de borde y esquinas | Edging tiles and corners | Pièces de bord et angles

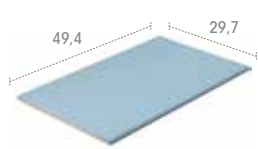
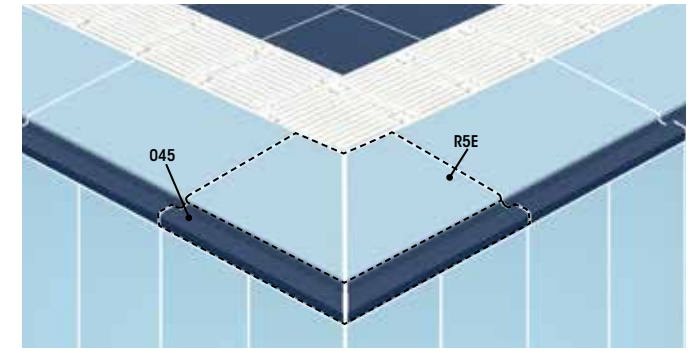
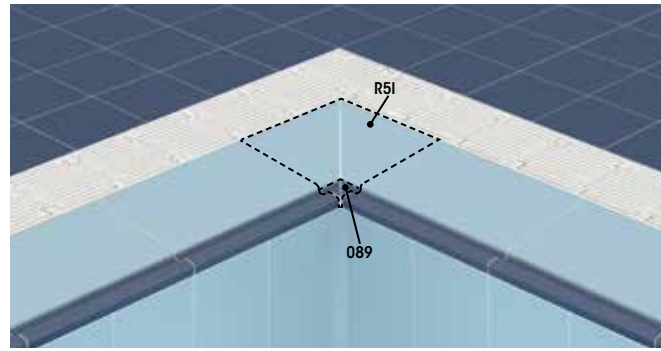
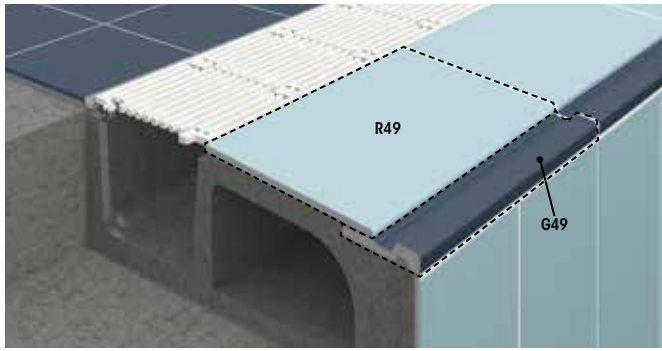

**R49**  
anti-slip



**G49**  
anti-slip

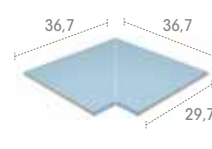

**R51**  
anti-slip



**O89**  
anti-slip

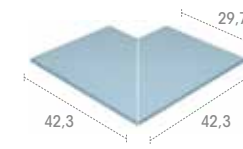

**R5E**  
anti-slip

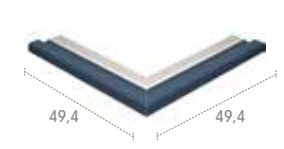

**O45**  
anti-slip



### Bloques S9 | S9 Blocks | Modules S9

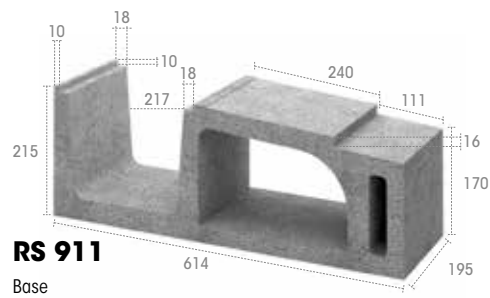

**RS 911**  
Base

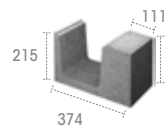

**RS 912**  
Escalera abierta  
Open built-in stairs  
Échelle ouverte

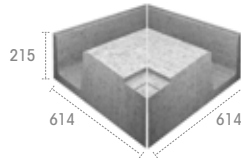

**RS 913**  
Esquina Interior  
Inside corner  
Angle intérieur

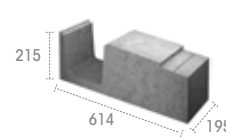

**RS 914**  
Maciza  
Solid  
Solide

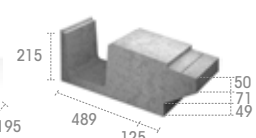

**RS 915**  
Escalera cerrada  
Closed built-in stairs  
Échelle fermée

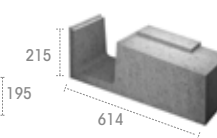

**RS 916**  
Escalera abierta,  
esquina derecha  
Open built-in stairs,  
right corner  
Échelle ouverte,  
coin droit

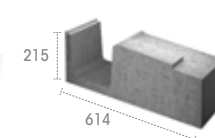

**RS 917**  
Escalera abierta,  
esquina izquierda  
Open built-in stairs,  
left corner  
Échelle ouverte,  
coin gauche

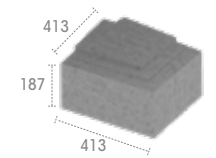

**RS 918**  
Esquina exterior  
Outside corner  
Angle extérieur



Sistema clásico de pre-playa descendente. Los bloques S9 proporcionan la pendiente necesaria y solucionan el apoyo de rejilla.

A classic downward-sloping pre-deck system. The S9 blocks provide the necessary slope and grate support.

Système classique d'avant-plage descendante. Les blocs S9 offrent la pente nécessaire et servent d'appui pour la grille.

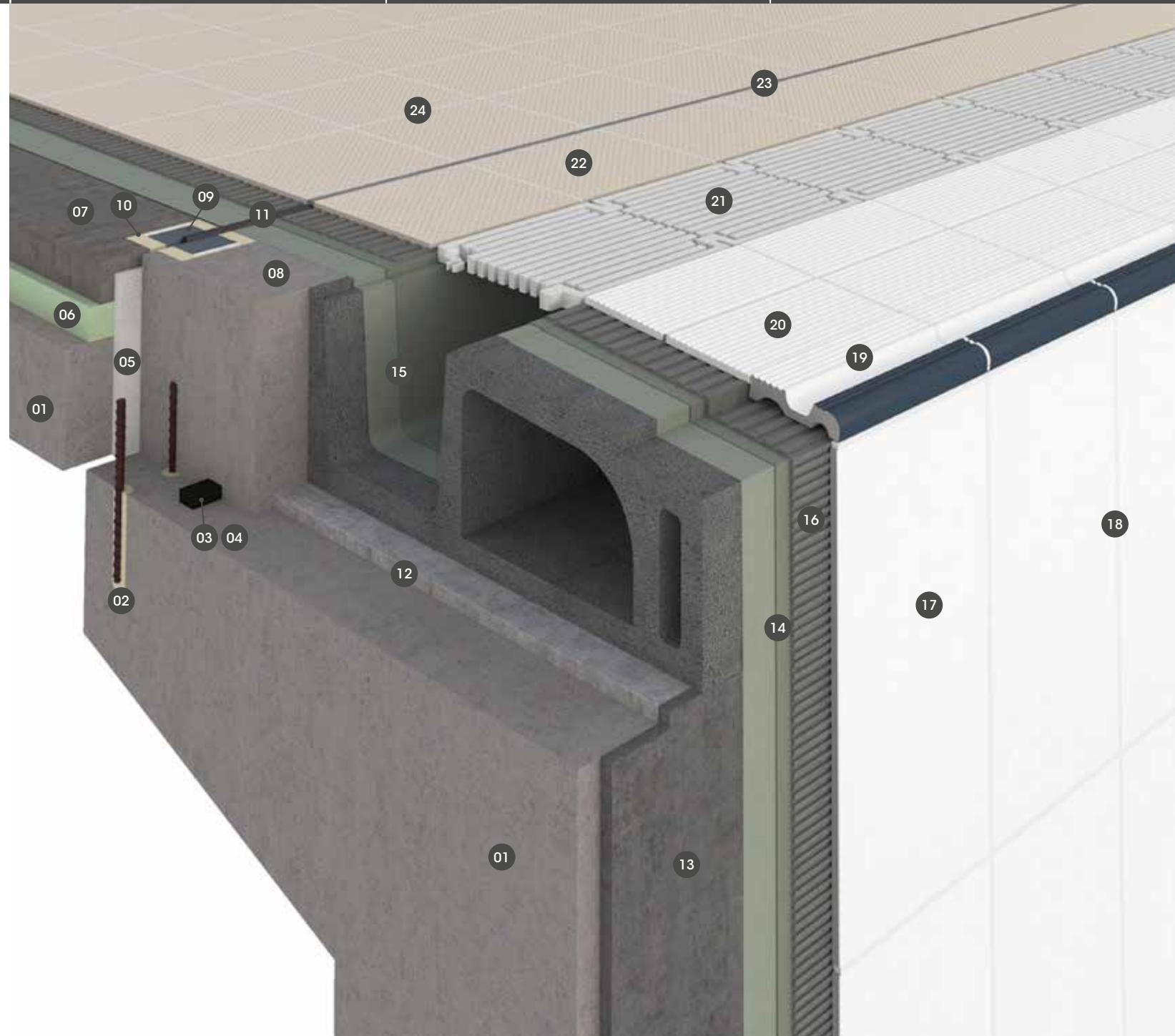

- 01 Estructura de hormigón del vaso  
Concrete structure of the tank  
Structure en béton de la piscine
- 02 **EPOXICOL**  
Mortero epoxi de anclaje  
Epoxy anchoring mortar  
Mortier époxy de calage
- 03 **FUGA-STOP MINI 20 x 10 mm**  
Junta hidro-expansiva  
Hydro-expanding waterstop  
Profilé d'étanchéité hydro-expansif
- 04 **MASTIC MS**  
Adhesivo para pegar la Fuga-Stop Mini  
Adhesive for sticking the Fuga-Stop Mini  
Adhésif pour coller le Fuga-Stop Mini
- 05 **POLIESTIRENO EXPANDIDO:**  
relleno de la junta de dilatación  
**EXPANDED POLYSTYRENE:**  
filling of the expansion joint  
**POLYSTYRÈNE EXPANSÉ:**  
remplissage du joint de dilatation
- 06 **POLIESTIRENO EXTRUSIONADO:**  
aislamiento térmico  
**EXTRUDED POLYSTYRENE:**  
thermal insulation  
**POLYSTYRÈNE EXTRUDÉ:**  
isolation thermique
- 07 **PAVIFORT**  
Mortero de recricado de las playas  
Pre-mixed mortar for screeds  
Mortier prêt à gâcher, pour la réalisation de chapes
- 08 Talón de hormigón posterior a las piezas S9  
Concrete wall behind the S9 pieces  
Mur de béton derrière les pièces S9
- 09 **FIX-TAPE 170 mm**  
Junta de dilatación elástica e impermeable  
Elastic and waterproof strip for expansion joints  
Bande élastique et imperméable pour les joints de dilatation
- 10 **EPOXICOL**  
Mortero epoxi adhesivo de la Fix-tape 170 mm  
Epoxy adhesive mortar for Fix-tape 170 mm  
Mortier-colle époxy pour Fix-tape 170 mm
- 11 **SELLALASTIC FOAM**  
Cordón elástico de relleno de la junta  
Closed cell to use as background filling in joints  
Profilé en polyéthylène à cellule fermée utilisée comme fond de joint
- 12 Mortero adhesivo de las piezas de S9 mejorado con Primfix  
Improved adhesive mortar with Primfix to fix S9 pieces  
Mortier amélioré avec Primfix pour fixer les pièces S9
- 13 **FIX-REVOCO**  
Mortero adhesivo para recricado de paredes  
Pre-mixed adhesive mortar for rendering walls  
Mortier prêt à gâcher, pour la réalisation de crépissages sur murs
- 14 **HIDROELASTIC**  
1ª y 2ª mano de la impermeabilización elástica  
1st and 2nd layer of elastic waterproofing  
1ère et 2ème couche d'imperméabilisation élastique
- 15 **HIDROFIX**  
1ª y 2ª mano de impermeabilización flexible  
1st and 2nd layer of flexible waterproofing  
1ère et 2ème couche d'imperméabilisation flexible
- 16 **TECNOCOL FLEX**  
Ultra-adhesivo para el pegado de la cerámica  
Maximum adherence glue-cement for sticking porcelain tiles  
Ciment colle flexible, à adhérence maximale pour la pose de grès cérame
- 17 **244 liso / anti-slip 24,4 x 49,4 cm Rosa Gres**  
Gres porcelánico  
Porcelain tile  
Grès cérame
- 18 **CERPOXI**  
Mortero de rejuntado epoxi anti-ácido  
100% impermeable  
Epoxy mortar, waterproof and acid proof for sealing joints.  
Époxy joint, extra fluide, imperméable et inattaquable par les acides
- 19 **007 anti-slip 24,4 x 11,9 cm Rosa Gres**  
Gres porcelánico  
Porcelain tile  
Grès cérame
- 20 **001 anti-slip 11,9 x 24,4 cm Rosa Gres**  
Gres porcelánico  
Porcelain tile  
Grès cérame
- 21 Rejilla de plástico  
Plastic grid  
Grille en plastique
- 22 **240 pastilla 24,4 x 24,4 cm Rosa Gres**  
Gres porcelánico  
Porcelain tile  
Grès cérame
- 23 **SELLALASTIC**  
Masilla de poliuretano de máxima elasticidad  
Polyurethane filler of extraordinary elasticity  
Mastic polyuréthane d'une extraordinaire élasticité.
- 24 **JUNTATEC**  
Mortero de rejuntado resistente a los ácidos débiles  
Mortar for sealing resistant to slight chemical aggressions  
Mortier pour le scellement de joint, résistant aux légères agressions chimiques



Deportivo Venustiano Carranza, Ciudad de México, México  
Plomo / Blanco / Mistery Grey

Finlandés - Finnish - Finlandais | Con S9 | With S9 | Avec S9

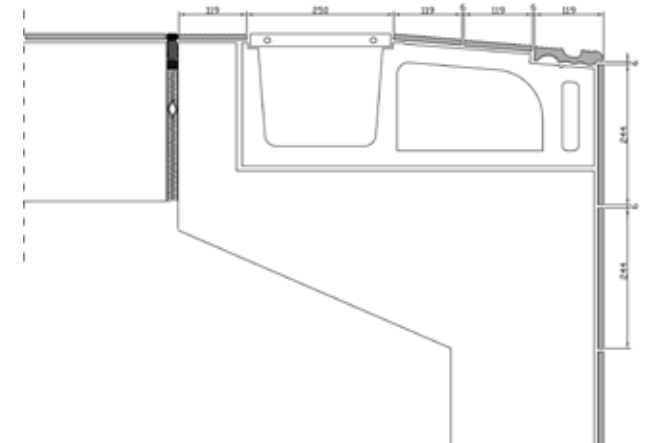

Finlandés - Finnish - Finlandais | Sin S9 | Without S9 | Sans S9

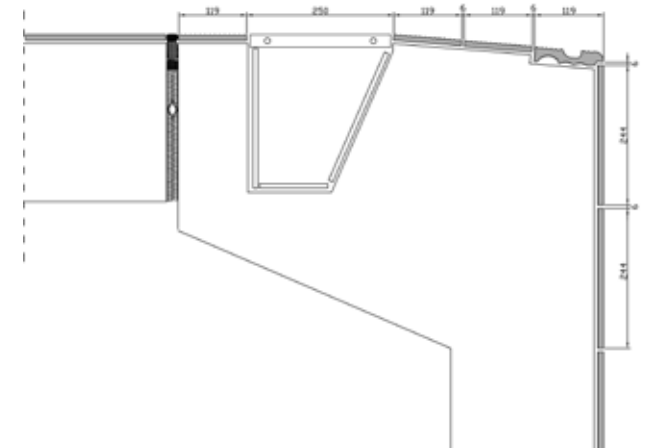



EL BORDE  
THE EDGE  
LE BORD

SISTEMAS DESBORDANTES ROSA GRES  
ROSA GRES DECK LEVEL POOL SYSTEMS  
SYSTÈMES À DÉBORDEMENT ROSA GRES

SISTEMA  
SYSTEM  
SYSTÈME

Finlandés  
Finnish  
Finlandais

PROGRAMA  
PROGRAM  
PROGRAMME

## Metro

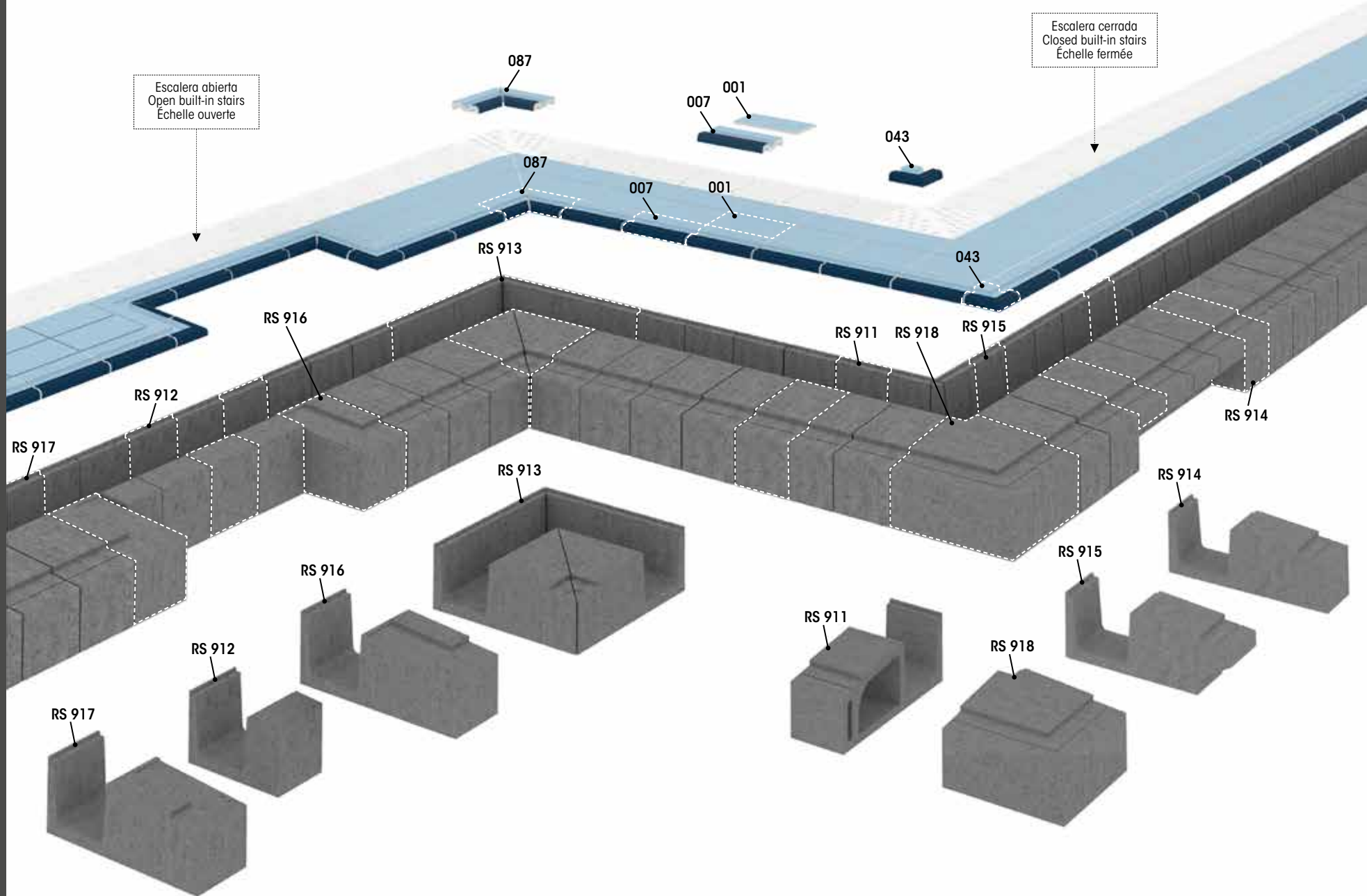

Piezas de borde y esquinas | Edging tiles and corners | Pièces de bord et angles

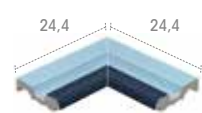
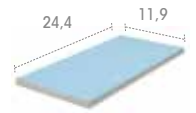
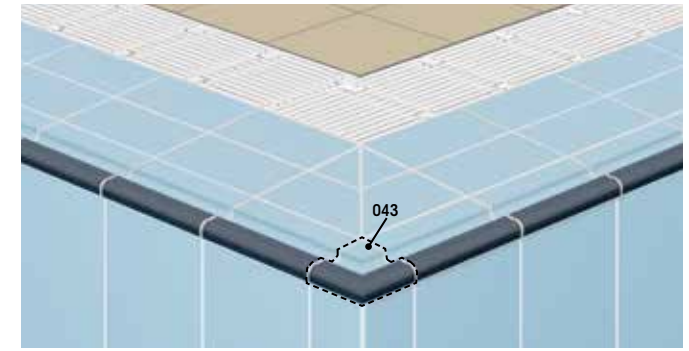
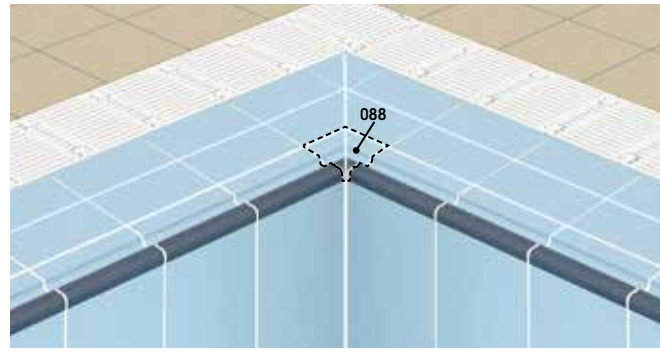
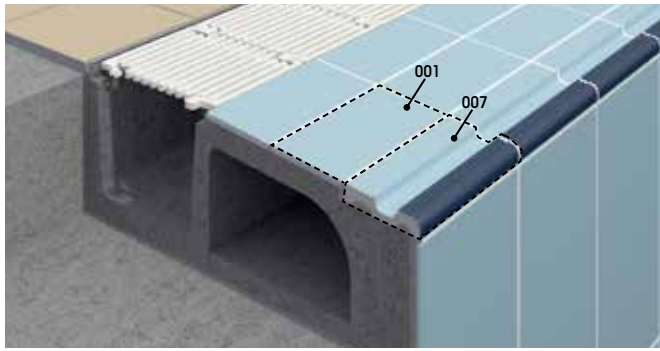

**001**  
anti-slip

**007**  
anti-slip

**087**  
anti-slip

**088**  
anti-slip

**043**  
anti-slip

**007M**  
anti-slip

**087M**  
anti-slip

**088M**  
anti-slip

**043M**  
anti-slip

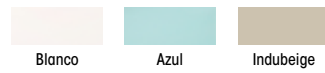

Bloques S9 | S9 Blocks | Modules S9

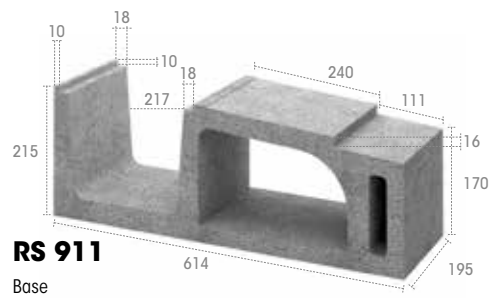

**RS 911**  
Base

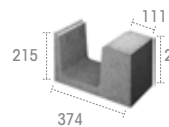

**RS 912**  
Escalera abierta  
Open built-in stairs  
Échelle ouverte

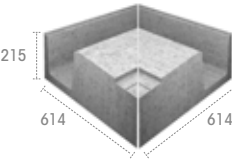

**RS 913**  
Esquina Interior  
Inside corner  
Angle intérieur

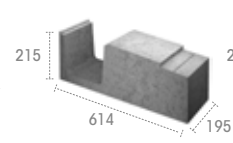

**RS 914**  
Maciza  
Solid  
Solide

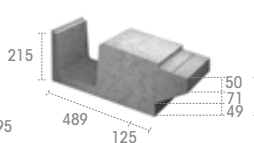

**RS 915**  
Escalera cerrada  
Closed built-in stairs  
Échelle fermée

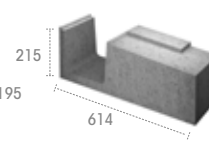

**RS 916**  
Escalera abierta,  
esquina derecha  
Open built-in stairs,  
right corner  
Échelle ouverte,  
coin droit

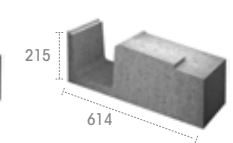

**RS 917**  
Escalera abierta,  
esquina izquierda  
Open built-in stairs,  
left corner  
Échelle ouverte,  
coin gauche

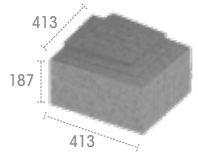

**RS 918**  
Esquina exterior  
Outside corner  
Angle extérieur



Sistema de pre-playa descendente solucionado con dos únicas piezas. La pieza de borde proporciona la pendiente de la pre-playa y actúa como soporte cerámico para la rejilla.

A downward-sloping pre-deck system with only two pieces. The edge piece provides the pre-deck slope and acts as a ceramic support for the grid.

Système d'avant-plage descendante constitué de 2 pièces. Le bord donne la pente de l'avant-plage et sert de support pour la grille. La pièce arrière côté plage sert aussi de support pour la grille.

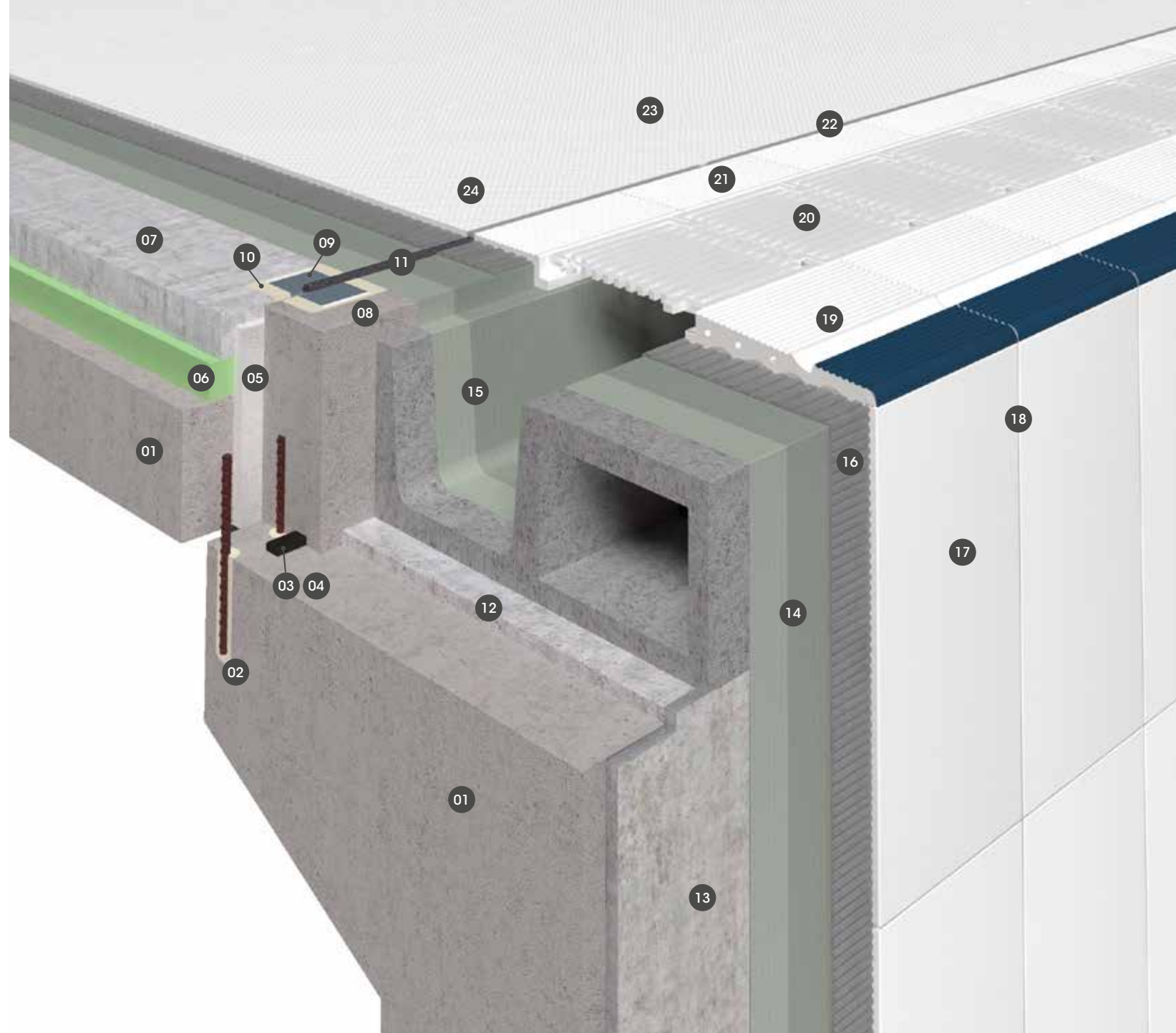

- 01** Estructura de hormigón del vaso  
Concrete structure of the tank  
Structure en béton de la piscine
- 02** **EPOXICOL**  
Mortero epoxi de anclaje  
Epoxy anchoring mortar  
Mortier époxy de calage
- 03** **FUGA-STOP MINI 20 x 10 mm**  
Junta hidro-expansiva  
Hydro-expanding waterstop  
Profilé d'étanchéité hydro-expansif
- 04** **MASTIC MS**  
Adhesivo para pegar la Fuga-Stop Mini  
Adhesive for sticking the Fuga-Stop Mini  
Adhésif pour coller le Fuga-Stop Mini
- 05** **POLIESTIRENO EXPANDIDO:**  
relleno de la junta de dilatación  
**EXPANDED POLYSTYRENE:**  
filling of the expansion joint  
**POLYSTYRÈNE EXPANSÉ:**  
remplissage du joint de dilatation
- 06** **POLIESTIRENO EXTRUSIONADO:**  
aislamiento térmico  
**EXTRUDED POLYSTYRENE:**  
thermal insulation  
**POLYSTYRÈNE EXTRUDÉ:**  
isolation thermique
- 07** **PAVIFORT**  
Mortero de recocado de las playas  
Pre-mixed mortar for screeds  
Mortier prêt à gâcher, pour la réalisation de chapes
- 08** Talón de hormigón posterior a las piezas S9  
Concrete wall behind the S9 pieces  
Mur de béton derrière les pièces S9
- 09** **FIX-TAPE 170 mm**  
Junta de dilatación elástica e impermeable  
Elastic and waterproof strip for expansion joints  
Bande élastique et imperméable pour les joints de dilatation
- 10** **EPOXICOL**  
Mortero epoxi adhesivo de la Fix-tape 170 mm  
Epoxy adhesive mortar for Fix-tape 170 mm  
Mortier-colle époxy pour Fix-tape 170 mm
- 11** **SELLALASTIC FOAM**  
Cordón elástico de relleno de la junta  
Closed cell to use as background filling in joints  
Profilé en polyéthylène à cellule fermée utilisée comme fond de joint
- 12** Mortero adhesivo de las piezas de S9 mejorado con Primfix  
Improved adhesive mortar with Primfix to fix S9 pieces  
Mortier amélioré avec Primfix pour fixer les pièces S9

- 13** **FIX-REVOCO**  
Mortero adhesivo para recocado de paredes  
Pre-mixed adhesive mortar for rendering walls  
Mortier prêt à gâcher, pour la réalisation de crépissages sur murs
- 14** **HIDROELASTIC**  
1ª y 2ª mano de la impermeabilización elástica  
1<sup>st</sup> and 2<sup>nd</sup> layer of elastic waterproofing  
1<sup>ère</sup> et 2<sup>ème</sup> couche d'imperméabilisation élastique
- 15** **HIDROFIX**  
1ª y 2ª mano de impermeabilización flexible  
1<sup>st</sup> and 2<sup>nd</sup> layer of flexible waterproofing  
1<sup>ère</sup> et 2<sup>ème</sup> couche d'imperméabilisation flexible
- 16** **TECNOCOL FLEX**  
Ultra-adhesivo para el pegado de la cerámica  
Maximum adherence glue-cement for sticking porcelain tiles  
Ciment colle flexible, à adhérence maximale pour la pose de grès cérame
- 17** **244 liso / anti-slip 24,4 x 49,4 cm Rosa Gres**  
Gres porcelánico  
Porcelain tile  
Grès cérame
- 18** **CERPOXI**  
Mortero de rejuntado epoxi anti-ácido  
100% impermeable  
Epoxy mortar, waterproof and acid proof for sealing joints.  
Époxy joint, extra fluide, imperméable et inattaquable par les acides
- 19** **216 anti-slip 24,4 x 26,2 cm Rosa Gres**  
Gres porcelánico  
Porcelain tile  
Grès cérame
- 20** Rejilla de plástico  
Plastic grid  
Grille en plastique
- 21** **035 anti-slip 24,4 x 13,4 cm Rosa Gres**  
Gres porcelánico  
Porcelain tile  
Grès cérame
- 22** **SELLALASTIC**  
Masilla de poliuretano de máxima elasticidad  
Polyurethane filler of extraordinary elasticity  
Mastic polyuréthane d'une extraordinaire élasticité.
- 23** **JUNTATEC**  
Mortero de rejuntado resistente a los ácidos débiles  
Mortar for sealing resistant to slight chemical aggressions  
Mortier pour le scellement de joint, résistant aux légères agressions chimiques
- 24** **240 pastilla 24,4 x 24,4 cm Rosa Gres**  
Gres porcelánico  
Porcelain tile  
Grès cérame



Complejo Deportivo Municipal La Granja, Vigo, Spain / Naos Arquitectura  
Acero

Ergo I Con S9 | With S9 | Avec S9

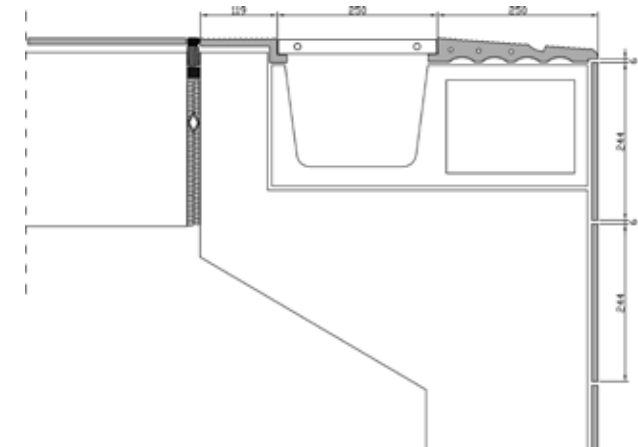

Ergo I Sin S9 | Without S9 | Sans S9

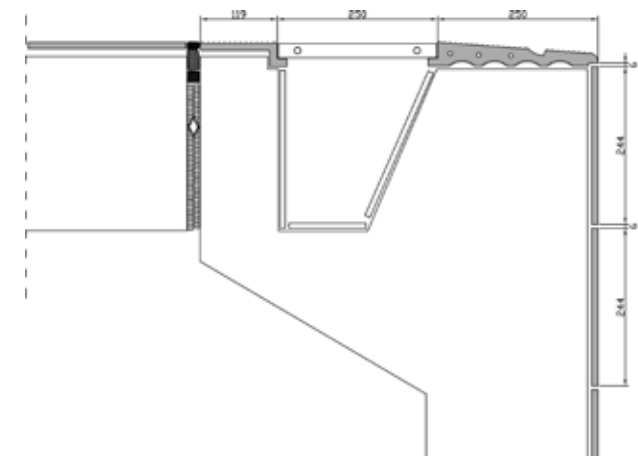



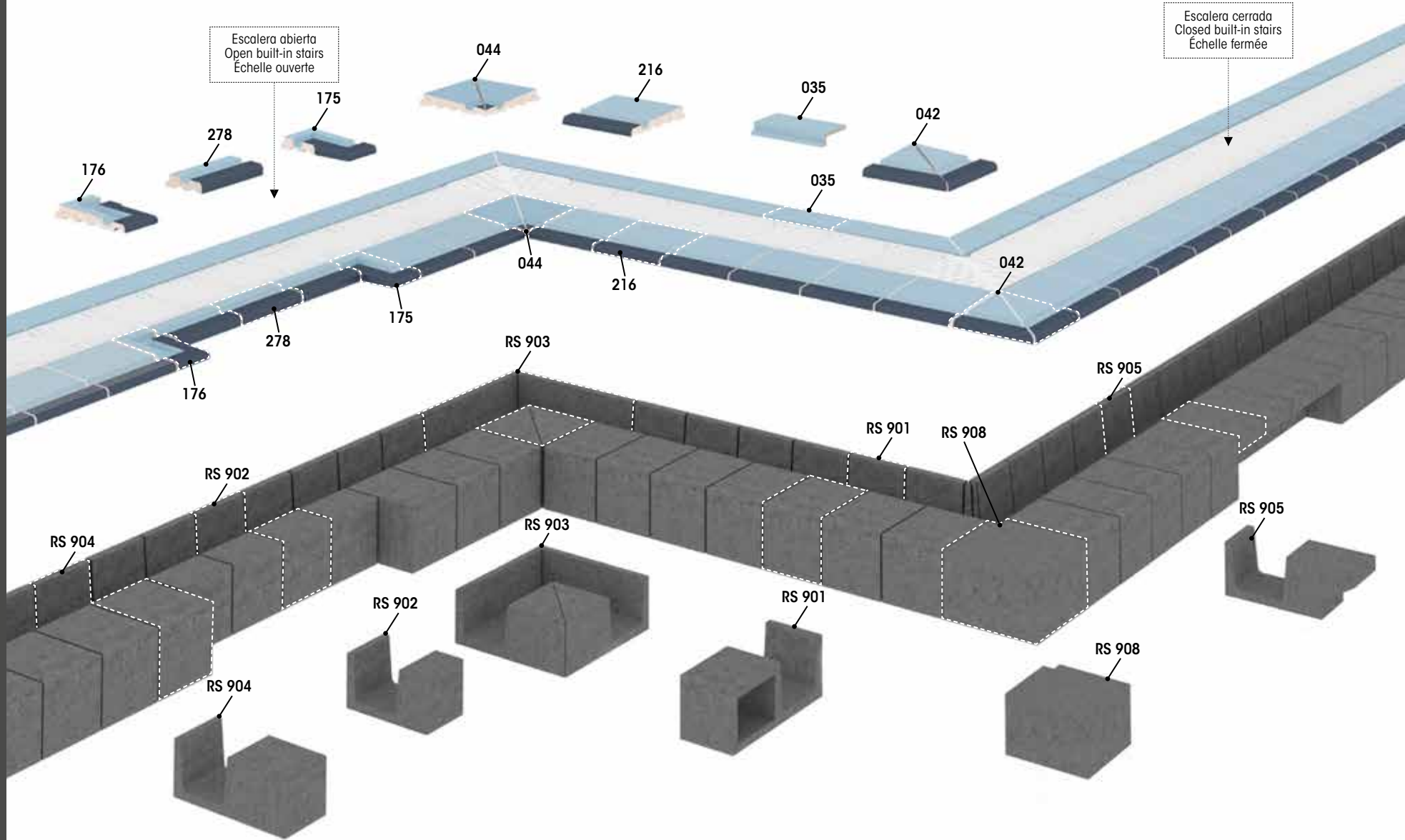

ERGO

Piezas de borde y esquinas | Edging tiles and corners | Pièces de bord et angles

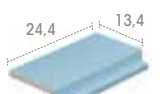
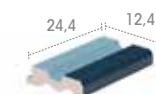
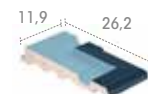
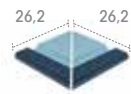
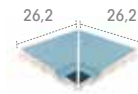
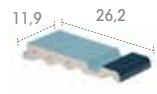
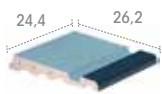
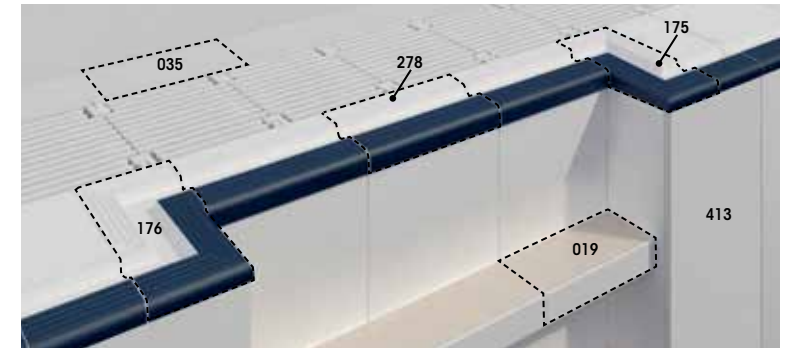
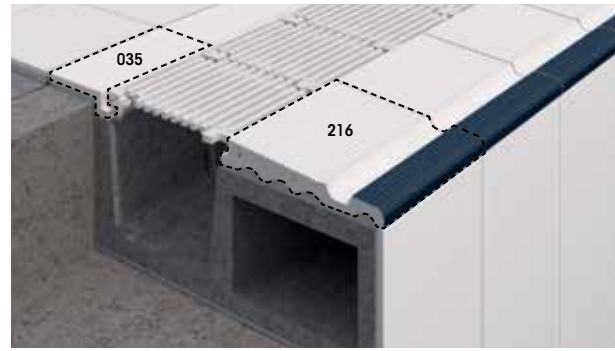
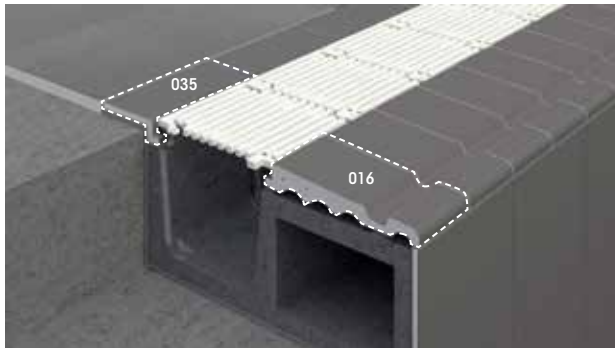

**216**  
anti-slip

**016**  
anti-slip

**044**  
anti-slip

**042**  
anti-slip

**176**  
anti-slip

**175**  
anti-slip

**178**  
anti-slip

**278**  
anti-slip

**035**  
anti-slip



Bloques S9 | S9 Blocks | Modules S9

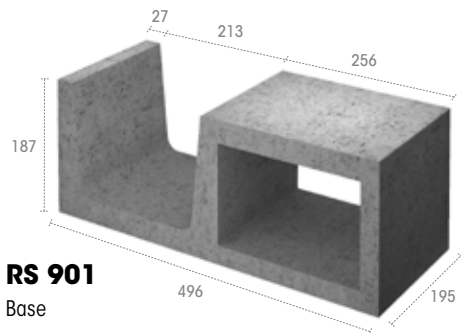

**RS 901**  
Base

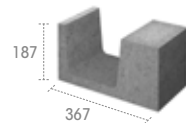

**RS 902**  
Escalera abierta  
Open built-in stairs  
Échelle ouverte

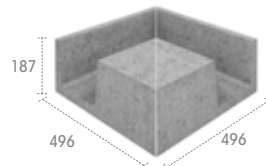

**RS 903**  
Esquina Interior  
Inside corner  
Angle intérieur

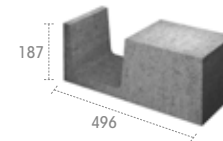

**RS 904**  
Maciza  
Solid  
Solide

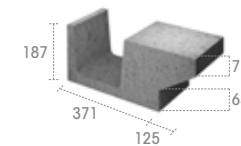

**RS 905**  
Escalera cerrada  
Closed built-in stairs  
Échelle fermée

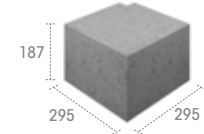

**RS 908**  
Esquina Exterior  
Outside corner  
Angle extérieur



Ideal cuando se dispone de poco espacio de playa y se requiere: coste reducido, garantía de estanqueidad, gran capacidad de canal y facilidad de colocación.

This is ideal if you have a limited pool deck area and require a low price, guaranteed watertightness, a high-capacity channel, an easy installation and a wide range of colors.

Idéal lorsque l'on dispose de peu d'espace pour la plage. Parmi les nombreux avantages: coût réduit, garantie d'étanchéité, grande capacité de canal, pose facile et large gamme de couleurs.

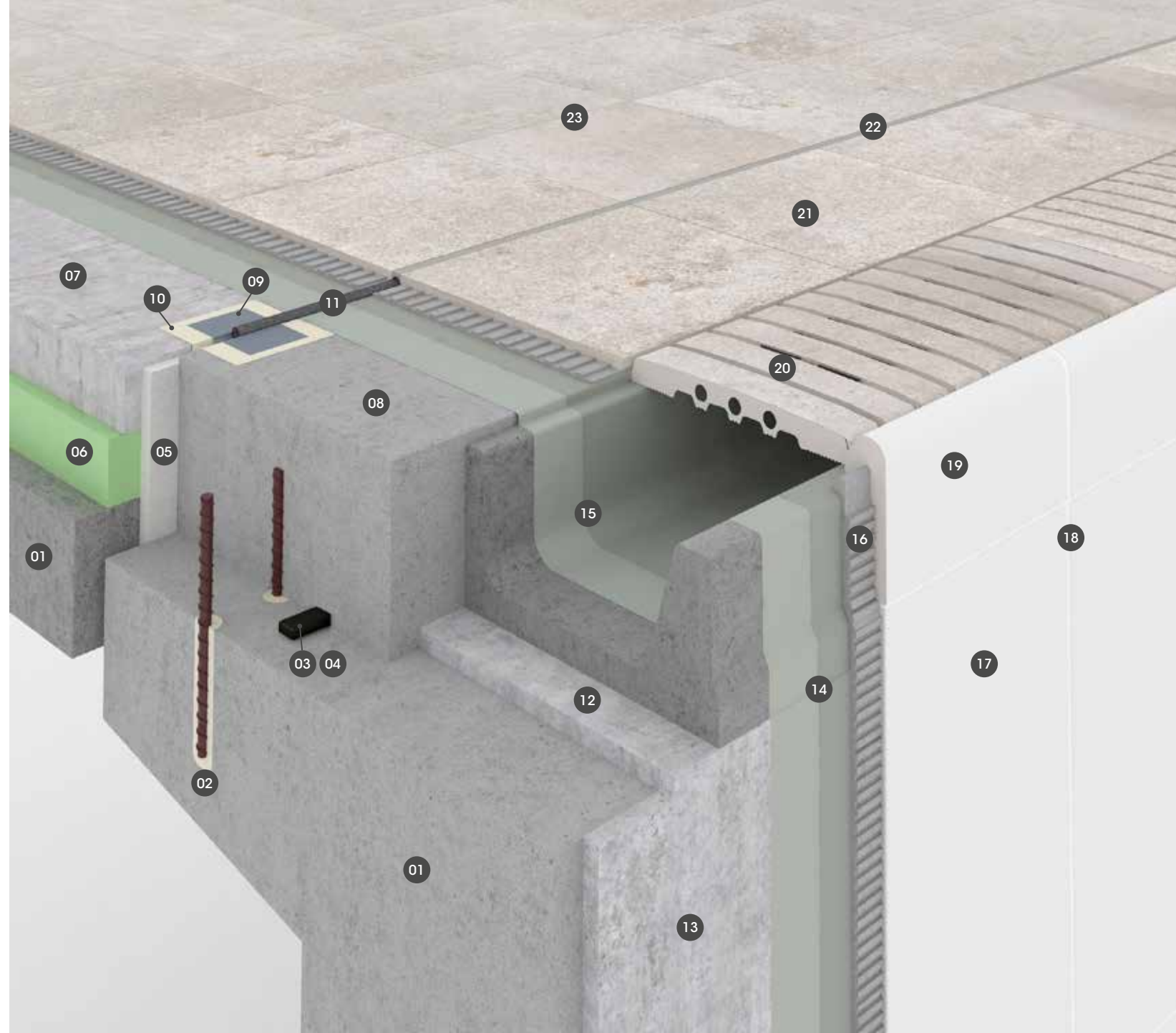

- 01** Estructura de hormigón del vaso  
Concrete structure of the tank  
Structure en béton de la piscine
- 02** **EPOXICOL**  
Mortero epoxi de anclaje  
Epoxy anchoring mortar  
Mortier époxy de calage
- 03** **FUGA-STOP MINI 20 x 10 mm**  
Junta hidro-expansiva  
Hydro-expanding waterstop  
Profilé d'étanchéité hydro-expansif
- 04** **MASTIC MS**  
Adhesivo para pegar la Fuga-Stop Mini  
Adhesive for sticking the Fuga-Stop Mini  
Adhésif pour coller le Fuga-Stop Mini
- 05** **POLIESTIRENO EXPANDIDO:**  
relleno de la junta de dilatación  
**EXPANDED POLYSTYRENE:**  
filling of the expansion joint  
**POLYSTYRÈNE EXPANSÉ:**  
remplissage du joint de dilatation
- 06** **POLIESTIRENO EXTRUSIONADO:**  
aislamiento térmico  
**EXTRUDED POLYSTYRENE:**  
thermal insulation  
**POLYSTYRÈNE EXTRUDÉ:**  
isolation thermique
- 07** **PAVIFORT**  
Mortero de recocado de las playas  
Pre-mixed mortar for screeds  
Mortier prêt à gâcher, pour la réalisation de chapes
- 08** Talón de hormigón posterior a las piezas S9  
Concrete wall behind the S9 pieces  
Mur de béton derrière les pièces S9
- 09** **FIX-TAPE 170 mm**  
Junta de dilatación elástica e impermeable  
Elastic and waterproof strip for expansion joints  
Bande élastique et imperméable pour les joints de dilatation
- 10** **EPOXICOL**  
Mortero epoxi adhesivo de la Fix-tape 170 mm  
Epoxy adhesive mortar for Fix-tape 170 mm  
Mortier-colle époxy pour Fix-tape 170 mm
- 11** **SELLALASTIC FOAM**  
Cordón elástico de relleno de la junta  
Closed cell to use as background filling in joints  
Profilé en polyéthylène à cellule fermée utilisée comme fond de joint
- 12** Mortero adhesivo de las piezas de S9 mejorado con Primfix  
Improved adhesive mortar with Primfix to fix S9 pieces  
Mortier amélioré avec Primfix pour fixer les pièces S9

- 13** **FIX-REVOCO**  
Mortero adhesivo para recocado de paredes  
Pre-mixed adhesive mortar for rendering walls  
Mortier prêt à gâcher, pour la réalisation de crépissages sur murs
- 14** **HIDROELASTIC**  
1ª y 2ª mano de la impermeabilización elástica  
1<sup>st</sup> and 2<sup>nd</sup> layer of elastic waterproofing  
1<sup>ère</sup> et 2<sup>ème</sup> couche d'imperméabilisation élastique
- 15** **HIDROFIX**  
1ª y 2ª mano de impermeabilización flexible  
1<sup>st</sup> and 2<sup>nd</sup> layer of flexible waterproofing  
1<sup>ère</sup> et 2<sup>ème</sup> couche d'imperméabilisation flexible
- 16** **TECNOCOL FLEX**  
Ultra-adhesivo para el pegado de la cerámica  
Maximum adherence glue-cement for sticking porcelain tiles  
Ciment colle flexible, à adhérence maximale pour la pose de grès cérame
- 17** **244 liso / anti-slip 24,4 x 49,4 cm Rosa Gres**  
Gres porcelánico  
Porcelain tile  
Grès cérame
- 18** **CERPOXI**  
Mortero de rejuntado epoxi anti-ácido  
100% impermeable  
Epoxy mortar, waterproof and acid proof for sealing joints.  
Époxy joint, extra fluide, imperméable et inattaquable par les acides
- 19** **971 liso / anti-slip 24,4 x 12 cm Rosa Gres**  
Gres porcelánico  
Porcelain tile  
Grès cérame
- 20** **245 FL anti-slip Mystery Grey 24,5 x 49,5 x 2,2 cm Rosa Gres**  
Rejilla Flex de gres porcelánico  
Porcelain tile Flex grid  
Grille Flex en grès cérame
- 21** **310 anti-slip Mystery Grey 31 x 31 x 0,9 cm Rosa Gres**  
Gres porcelánico  
Porcelain tile  
Grès cérame
- 22** **SELLALASTIC**  
Masilla de poliuretano de máxima elasticidad  
Polyurethane filler of extraordinary elasticity  
Mastic polyuréthane d'une extraordinaire élasticité.
- 23** **JUNTATEC**  
Mortero de rejuntado resistente a los ácidos débiles  
Mortar for sealing resistant to slight chemical aggressions  
Mortier pour le scellement de joint, résistant aux légères agressions chimiques



Wiesbaden | Con S9 | With S9 | Avec S9

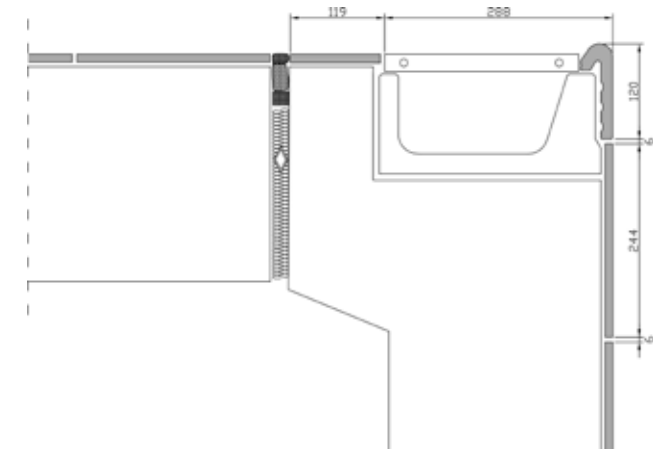



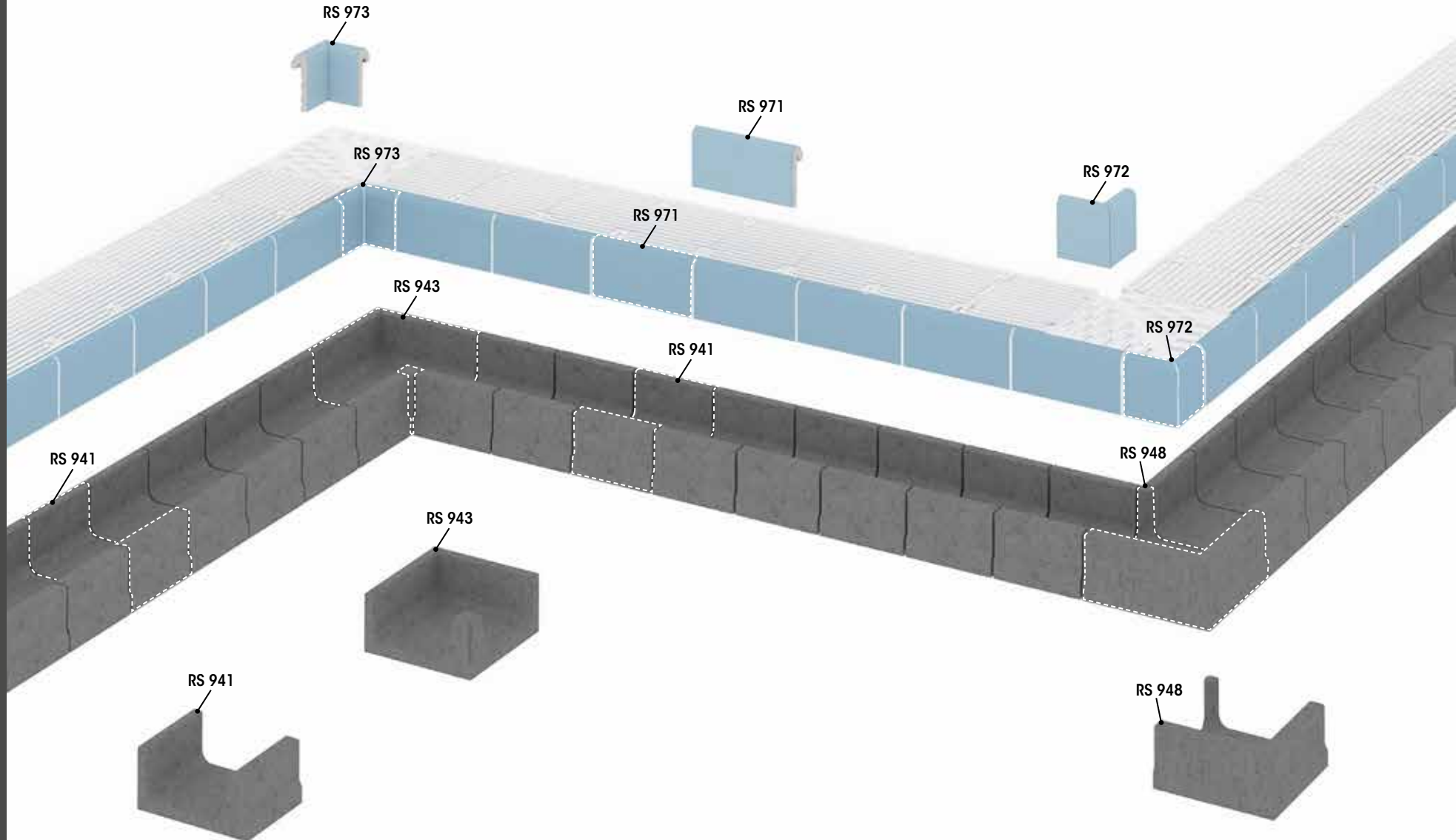

Piezas de borde y esquinas | Edging tiles and corners | Pièces de bord et angles

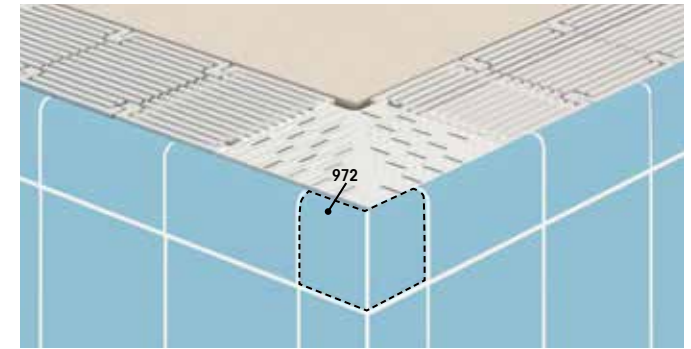
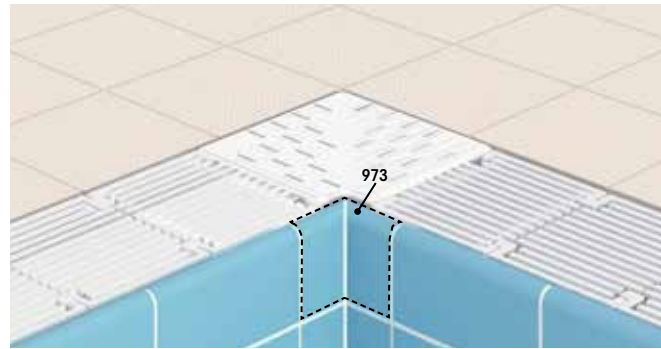
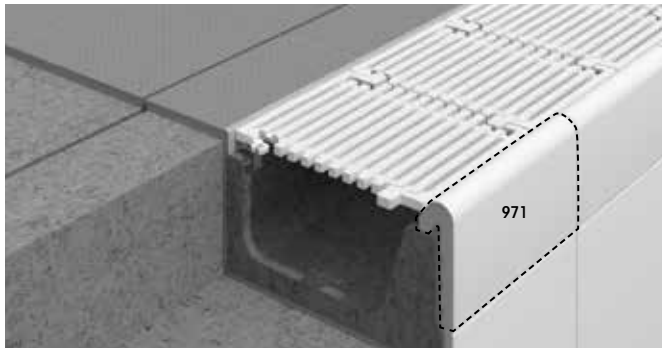

**971**  
liso / anti-slip

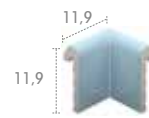

**973**  
liso / anti-slip



**972**  
liso / anti-slip



Bloques S9 | S9 Blocks | Modules S9

**RS 941**

Base

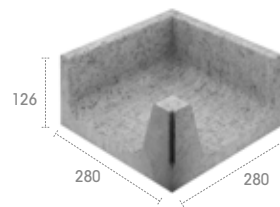
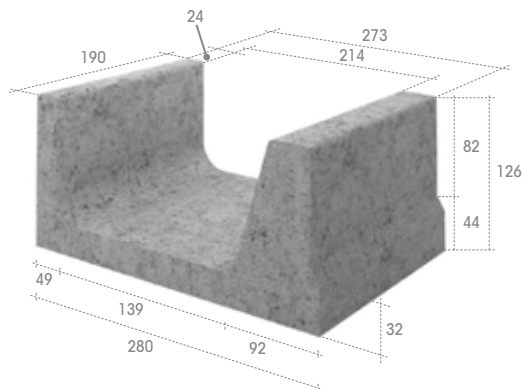

**RS 943**

Esquina Interior  
Inside corner  
Angle intérieur

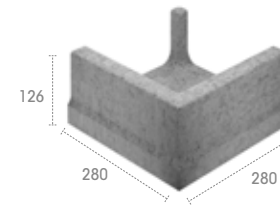

**RS 948**

Esquina Exterior  
Outside corner  
Angle extérieur



Creada para simplificar la construcción de piscinas desbordantes con mosaico, tanto públicas como residenciales. Sus principales ventajas son: facilidad de construcción, coste reducido, rapidez, poco espacio e infinidad de combinaciones de colores.

Created to simplify the construction of deck level pools with mosaic, both public and private. Its main advantages are ease of construction, low cost, speed, reduced space and the vast range of colour combinations.

Créé pour simplifier la construction des piscines à débordement avec mosaïque, aussi bien publiques que résidentielles. Ses principaux avantages sont: construction simplifiée, coût réduit, rapidité, espace réduit et une infinité de combinaisons de couleurs.

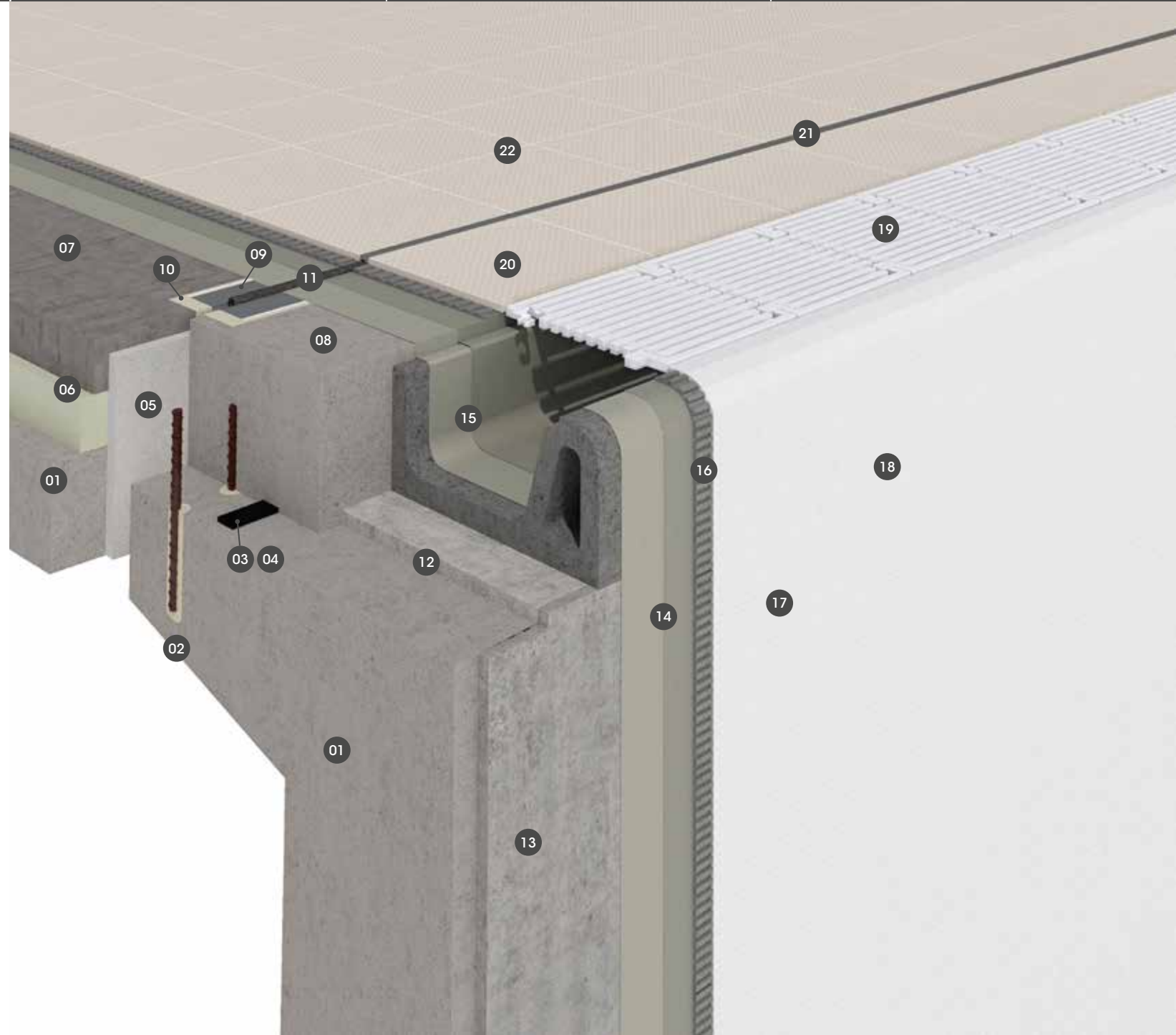

- 01 Estructura de hormigón del vaso  
Concrete structure of the tank  
Structure en béton de la piscine
- 02 **EPOXICOL**  
Mortero epoxi de anclaje  
Epoxy anchoring mortar  
Mortier époxy de calage
- 03 **FUGA-STOP MINI 20 x 10 mm**  
Junta hidro-expansiva  
Hydro-expanding waterstop  
Profilé d'étanchéité hydro-expansif
- 04 **MASTIC MS**  
Adhesivo para pegar la Fuga-Stop Mini  
Adhesive for sticking the Fuga-Stop Mini  
Adhésif pour coller le Fuga-Stop Mini
- 05 **POLIESTIRENO EXPANDIDO:**  
relleno de la junta de dilatación  
**EXPANDED POLYSTYRENE:**  
filling of the expansion joint  
**POLYSTYRÈNE EXPANSÉ:**  
remplissage du joint de dilatation
- 06 **POLIESTIRENO EXTRUSIONADO:**  
aislamiento térmico  
**EXTRUDED POLYSTYRENE:**  
thermal insulation  
**POLYSTYRÈNE EXTRUDÉ:**  
isolation thermique
- 07 **PAVIFORT**  
Mortero de recocado de las playas  
Pre-mixed mortar for screeds  
Mortier prêt à gâcher, pour la réalisation de chapes
- 08 Talón de hormigón posterior a las piezas S9  
Concrete wall behind the S9 pieces  
Mur de béton derrière les pièces S9
- 09 **FIX-TAPE 170 mm**  
Junta de dilatación elástica e impermeable  
Elastic and waterproof strip for expansion joints  
Bande élastique et imperméable pour les joints de dilatation
- 10 **EPOXICOL**  
Mortero epoxi adhesivo de la Fix-tape 170 mm  
Epoxy adhesive mortar for Fix-tape 170 mm  
Mortier-colle époxy pour Fix-tape 170 mm
- 11 **SELLALASTIC FOAM**  
Cordón elástico de relleno de la junta  
Closed cell to use as background filling in joints  
Profilé en polyéthylène à cellule fermée utilisée comme fond de joint
- 12 Mortero adhesivo de las piezas de S9 mejorado con Primfix  
Improved adhesive mortar with Primfix to fix S9 pieces  
Mortier amélioré avec Primfix pour fixer les pièces S9

- 13 **FIX-REVOCO**  
Mortero adhesivo para recocado de paredes  
Pre-mixed adhesive mortar for rendering walls  
Mortier prêt à gâcher, pour la réalisation de crépissages sur murs
- 14 **HIDROELASTIC**  
1ª y 2ª mano de la impermeabilización elástica  
1<sup>st</sup> and 2<sup>nd</sup> layer of elastic waterproofing  
1<sup>ère</sup> et 2<sup>de</sup> couche d'imperméabilisation élastique
- 15 **HIDROFIX**  
1ª y 2ª mano de impermeabilización flexible  
1<sup>st</sup> and 2<sup>nd</sup> layer of flexible waterproofing  
1<sup>ère</sup> et 2<sup>de</sup> couche d'imperméabilisation flexible
- 16 **TECNOCOL FLEX**  
Ultra-adhesivo para el pegado de la cerámica  
Maximum adherence glue-cement for sticking porcelain tiles  
Ciment colle flexible, à adhérence maximale pour la pose de grès cérame
- 17 **323 liso / anti-slip 33 x 33 x 0,5 cm Rosa Gres**  
Mosaico  
Mosaic  
Mosaïque
- 18 **CERPOXI**  
Mortero de rejuntado epoxi anti-ácido  
100% impermeable  
Epoxy mortar, waterproof and acid proof for sealing joints.  
Époxy joint, extra fluide, imperméable et inattaquable par les acides
- 19 Rejilla de plástico  
Plastic grid  
Grille en plastique
- 20 **240 pastilla 24,4 x 24,4 cm Rosa Gres**  
Gres porcelánico  
Porcelain tile  
Grès cérame
- 21 **SELLALASTIC**  
Masilla de poliuretano de máxima elasticidad  
Polyurethane filler of extraordinary elasticity  
Mastic polyuréthane d'une extraordinaire élasticité.
- 22 **JUNTATEC**  
Mortero de rejuntado resistente a los ácidos débiles  
Mortar for sealing resistant to slight chemical aggressions  
Mortier pour le scellement de joint, résistant aux légères agressions chimiques



Spa | Con S9 | With S9 | Avec S9

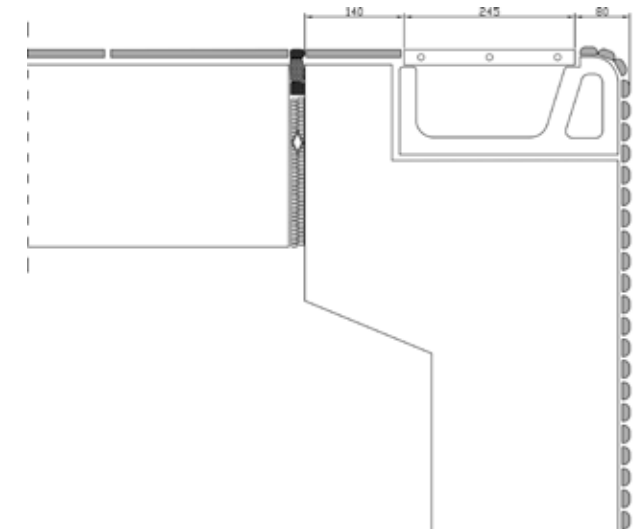



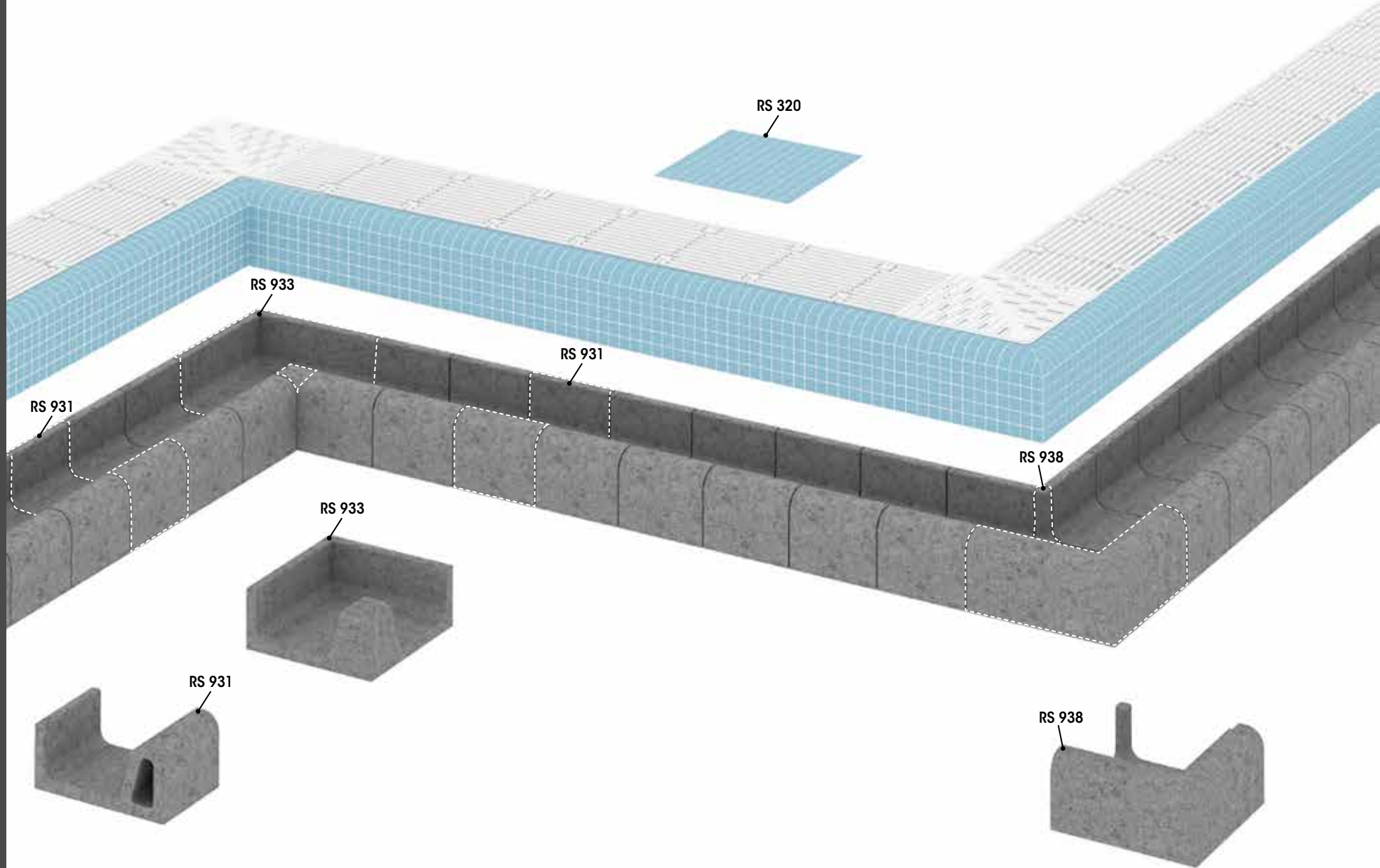

Piezas de borde | Edging tiles | Pièces de bord

320  
liso / anti-slip  
33 x 33 x 0,5  
2,3 x 2,3 / u

323  
liso / anti-slip  
33 x 33 x 0,5  
2,3 x 4,6 / u



Ref. 320  
Mosaic Blanco

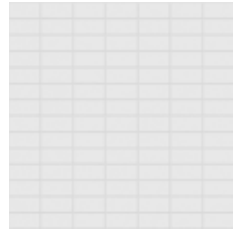

Ref. 323  
Mosaic Blanco

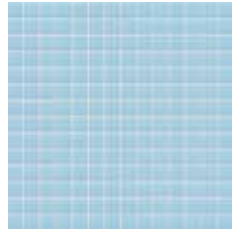

Ref. 320  
Mosaic Azul

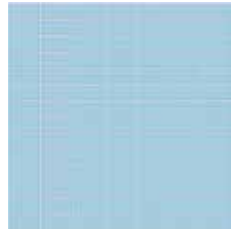

Ref. 323  
Mosaic Azul

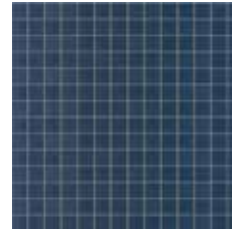

Ref. 320  
Mosaic Marino

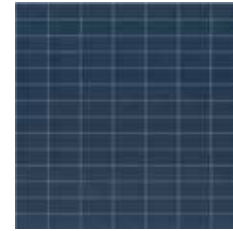

Ref. 323  
Mosaic Marino

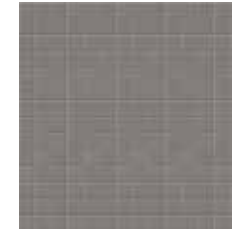

Ref. 320  
Mosaic Acero

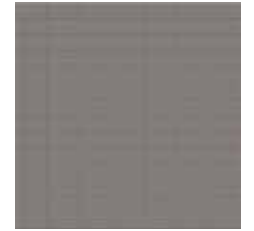

Ref. 323  
Mosaic Acero

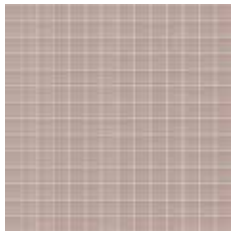

Ref. 320  
Mosaic Caramel

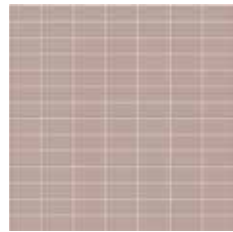

Ref. 323  
Mosaic Caramel

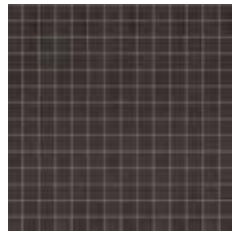

Ref. 320  
Mosaic Plomo

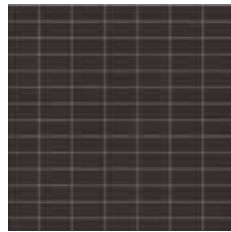

Ref. 323  
Mosaic Plomo



Ref. 320  
Mosaic Ivory



Ref. 323  
Mosaic Ivory

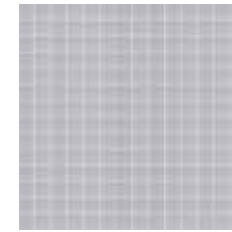

Ref. 320  
Mosaic Perla

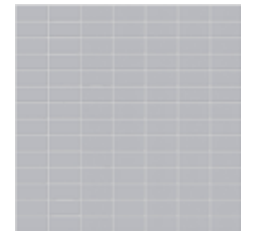

Ref. 323  
Mosaic Perla

Bloques S9 | S9 Blocks | Modules S9

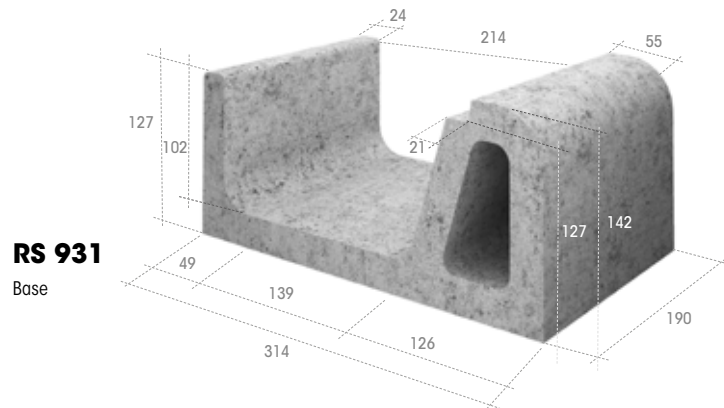

**RS 931**

Base

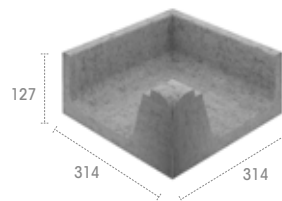

**RS 933**

Esquina Interior  
Inside corner  
Angle intérieur

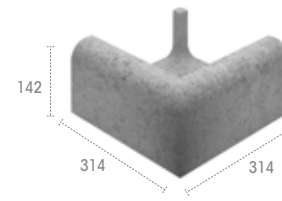

**RS 938**

Esquina Exterior  
Outside corner  
Angle extérieur



Pieza con el borde redondeado para facilitar el agarre. Una bella estética que consigue un plano de agua de 2 cm por encima de la playa circundante.

Piece with a rounded edge that it is easy to hold on to. An attractive way of achieving 2 cm of water above deck level.

Pièce a bord arrondi pour s'accrocher facilement. Le plan d'eau obtenu à 2 cm au dessus de la plage environnante, est très esthétique.

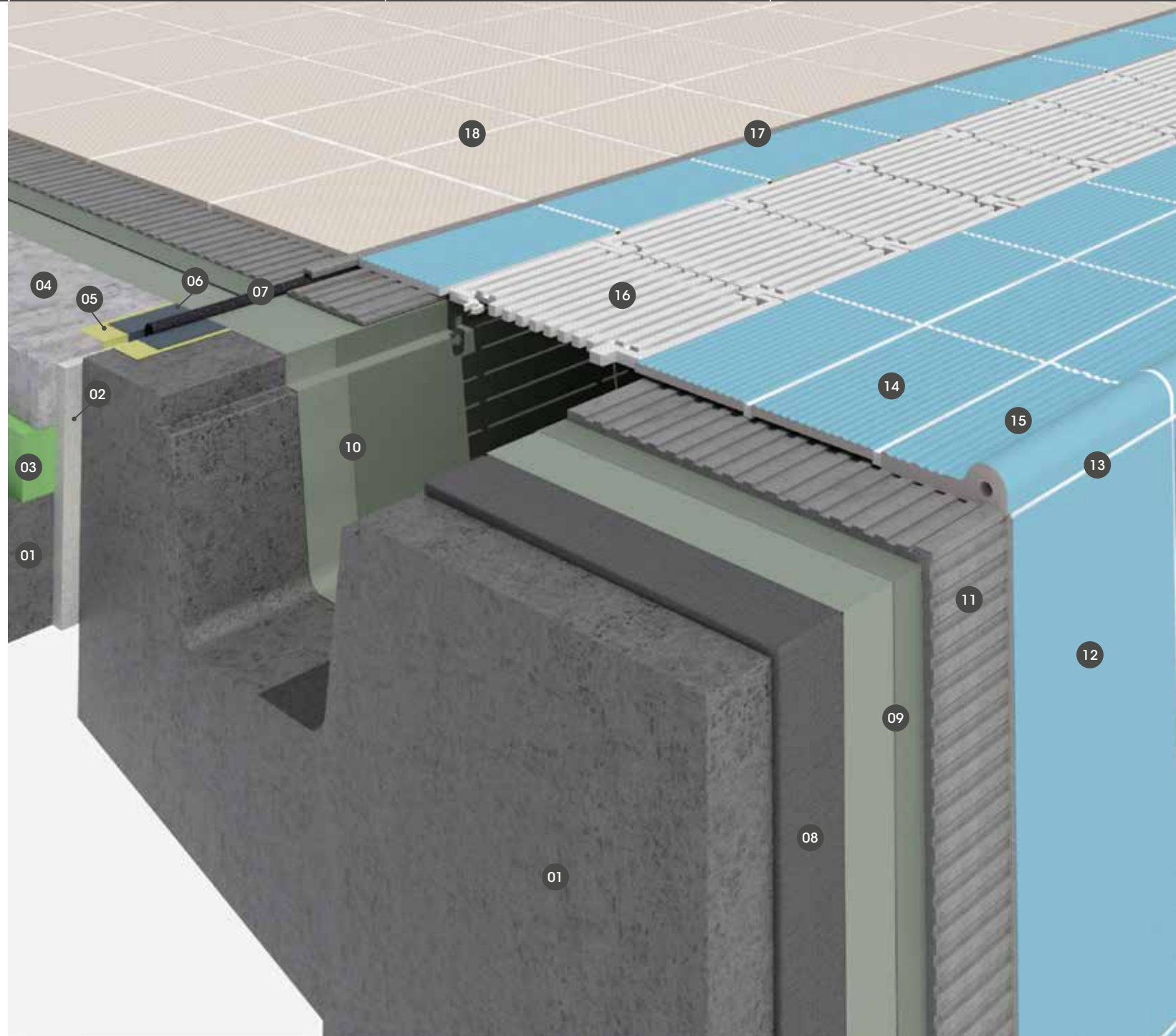

- 01 Estructura de hormigón del vaso  
Concrete structure of the tank  
Structure en béton de la piscine
- 02 **POLIESTIRENO EXPANDIDO:**  
relleno de la junta de dilatación  
**EXPANDED POLYSTYRENE:**  
filling of the expansion joint  
**POLYSTYRÈNE EXPANSÉ:**  
remplissage du joint de dilatation
- 03 **POLIESTIRENO EXTRUSIONADO:**  
aislamiento térmico  
**EXTRUDED POLYSTYRENE:**  
thermal insulation  
**POLYSTYRÈNE EXTRUDÉ:**  
isolation thermique
- 04 **PAVIFORT**  
Mortero de recrecido de las playas  
Pre-mixed mortar for screeds  
Mortier prêt à gâcher, pour la réalisation de chapes
- 05 **FIX-TAPE 170 mm**  
Junta de dilatación elástica e impermeable  
Elastic and waterproof strip for expansion joints  
Bande élastique et imperméable pour les joints de dilatation
- 06 **EPOXICOL**  
Mortero epoxi adhesivo de la Fix-tape 170 mm  
Epoxy adhesive mortar for Fix-tape 170 mm  
Mortier-colle époxy pour Fix-tape 170 mm
- 07 **SELLALASTIC FOAM**  
Cordón elástico de relleno de la junta  
Closed cell to use as background filling in joints  
Profilé en polyéthylène à cellule fermée utilisée comme fond de joint
- 08 **FIX-REVOCO**  
Mortero adhesivo para recrecido de paredes  
Pre-mixed adhesive mortar for rendering walls  
Mortier prêt à gâcher, pour la réalisation de crépissages sur murs
- 09 **HIDROELASTIC**  
1ª y 2ª mano de la impermeabilización elástica  
1<sup>st</sup> and 2<sup>nd</sup> layer of elastic waterproofing  
1<sup>ère</sup> et 2<sup>ème</sup> couche d'imperméabilisation élastique
- 10 **HIDROFIX**  
1ª y 2ª mano de impermeabilización flexible  
1<sup>st</sup> and 2<sup>nd</sup> layer of flexible waterproofing  
1<sup>ère</sup> et 2<sup>ème</sup> couche d'imperméabilisation flexible
- 11 **TECNOCOL FLEX**  
Ultra-adhesivo para el pegado de la cerámica  
Maximum adherence glue-cement for sticking porcelain tiles  
Ciment colle flexible, à adhérence maximale pour la pose de grès cérame

- 12 **244 liso / anti-slip 24,4 x 49,4 cm Rosa Gres**  
Gres porcelánico  
Porcelain tile  
Grès cérame
- 13 **CERPOXI**  
Mortero de rejuntado epoxi anti-ácido  
100% impermeable  
Epoxy mortar, waterproof and acid proof for sealing joints  
Époxy joint, extra fluide, imperméable et inattaquable par les acides
- 14 **001 antislip 11,9 x 24,4 cm Rosa Gres**  
Gres porcelánico  
Porcelain tile  
Grès cérame
- 15 **008 antislip 24,4 x 11,3 cm Rosa Gres**  
Gres porcelánico  
Porcelain tile  
Grès cérame
- 16 **Rejilla de plástico**  
Plastic grid  
Grille en plastique
- 17 **SELLALASTIC**  
Masilla de poliuretano de máxima elasticidad  
Polyurethane filler of extraordinary elasticity  
Mastic polyuréthane d'une extraordinaire élasticité
- 18 **JUNTATEC**  
Mortero de rejuntado resistente a los ácidos débiles  
Mortar for sealing resistant to slight chemical aggressions  
Mortier pour le scellement de joint, résistant aux légères agressions chimiques



Club Moving, Cluj-Napoca, Romania  
Azul

## Piezas de borde | Edging tiles | Pièces de bord

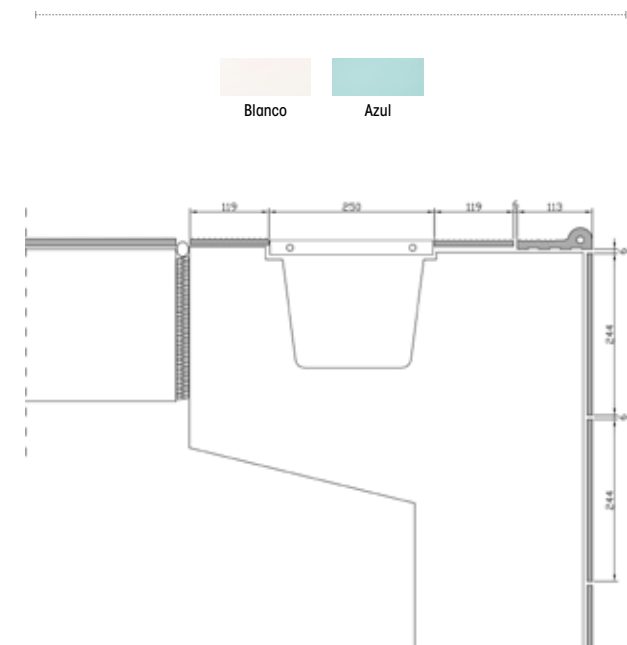
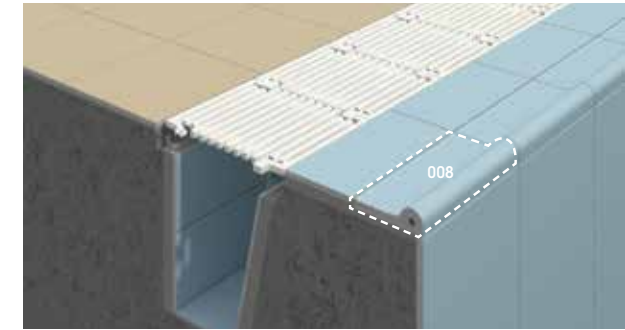



02

EL BORDE  
THE EDGE  
LE BORD

SISTEMAS DESBORDANTES ROSA GRES  
ROSA GRES DECK LEVEL POOL SYSTEMS  
SYSTÈMES À DÉBORDEMENT ROSA GRES

SISTEMA  
SYSTEM  
SYSTÈME

Australia A

PROGRAMA  
PROGRAM  
PROGRAMME

Metro

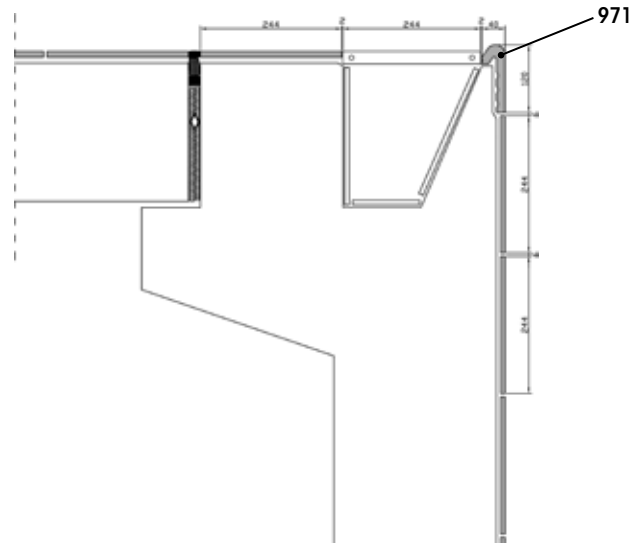
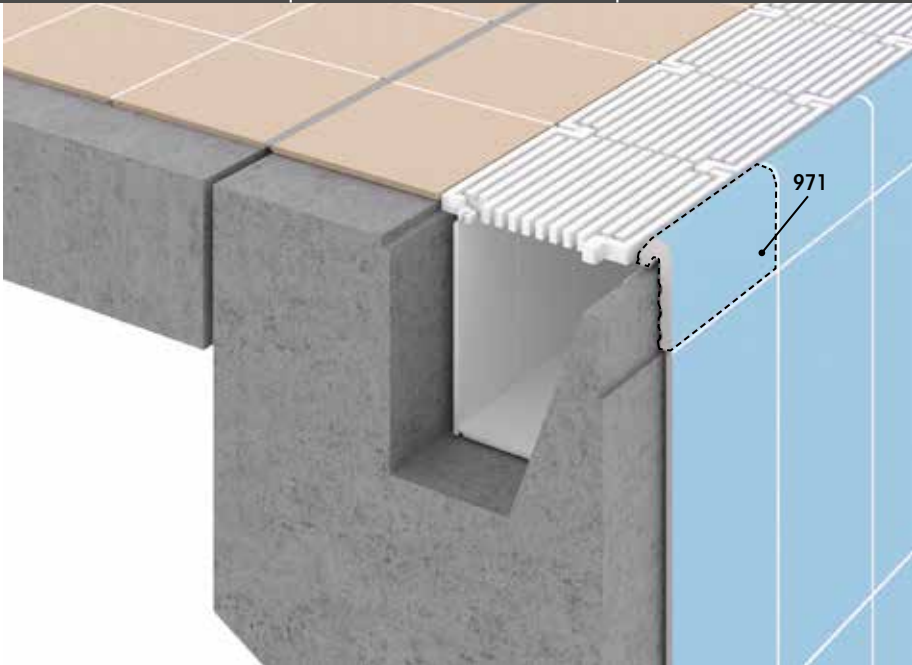

02

EL BORDE  
THE EDGE  
LE BORD

SISTEMAS DESBORDANTES ROSA GRES  
ROSA GRES DECK LEVEL POOL SYSTEMS  
SYSTÈMES À DÉBORDEMENT ROSA GRES

SISTEMA  
SYSTEM  
SYSTÈME

Munich

PROGRAMA  
PROGRAM  
PROGRAMME

Metro

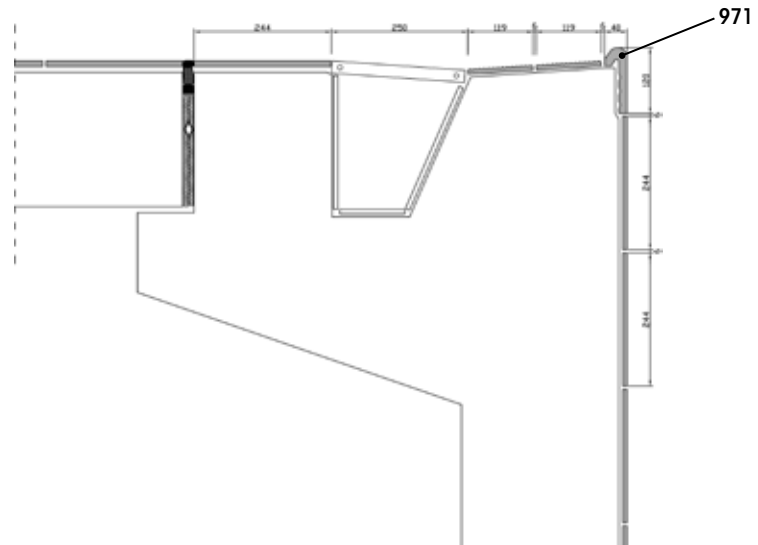
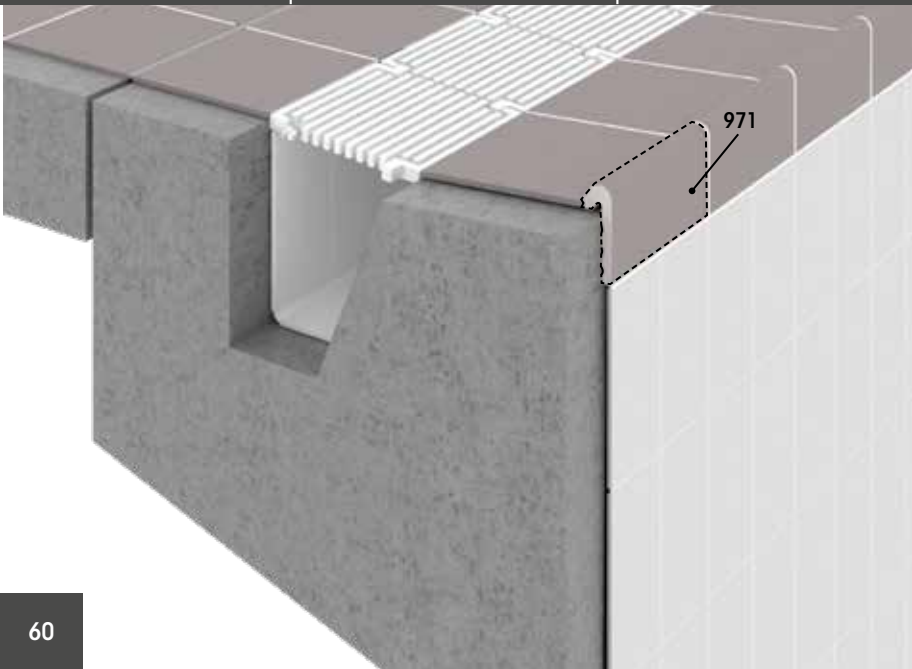

02

EL BORDE  
THE EDGE  
LE BORD

SISTEMAS DESBORDANTES ROSA GRES  
ROSA GRES DECK LEVEL POOL SYSTEMS  
SYSTÈMES À DÉBORDEMENT ROSA GRES

SISTEMA  
SYSTEM  
SYSTÈME

Australia B

PROGRAMA  
PROGRAM  
PROGRAMME

Metro

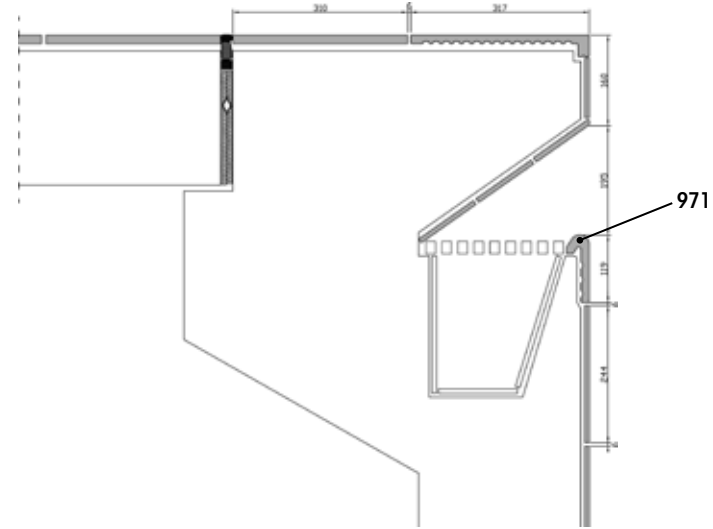
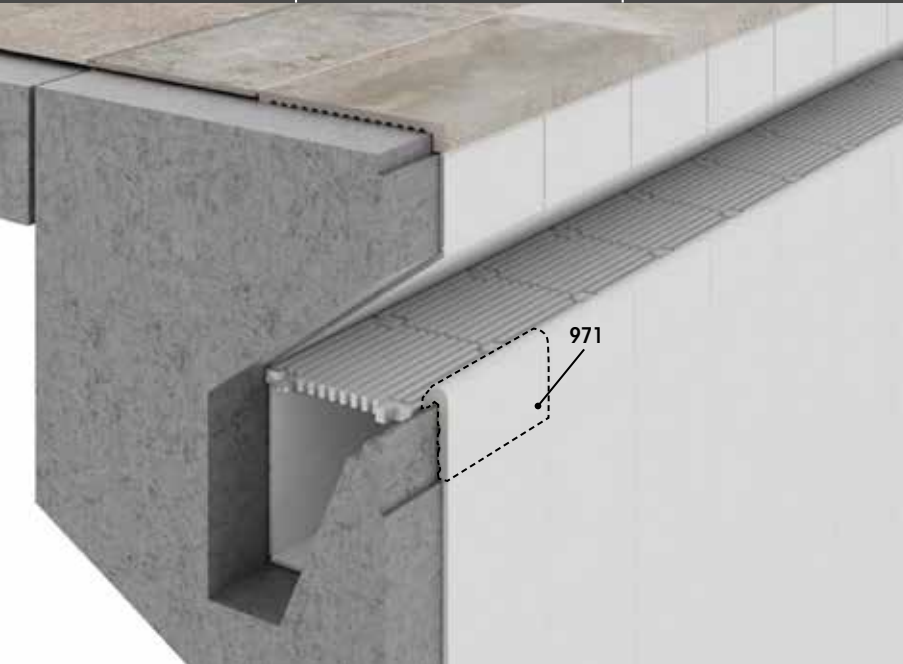

02

EL BORDE  
THE EDGE  
LE BORD

SISTEMAS DESBORDANTES ROSA GRES  
ROSA GRES DECK LEVEL POOL SYSTEMS  
SYSTÈMES À DÉBORDEMENT ROSA GRES

SISTEMA  
SYSTEM  
SYSTÈME

Wiesbaden B

PROGRAMA  
PROGRAM  
PROGRAMME

Metro

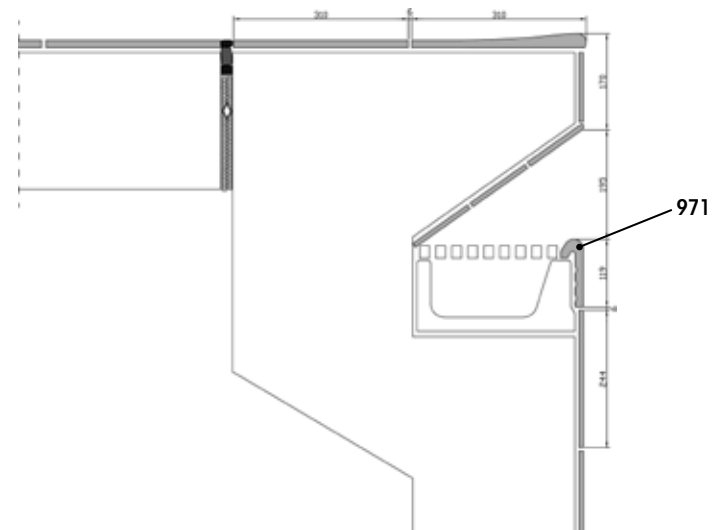
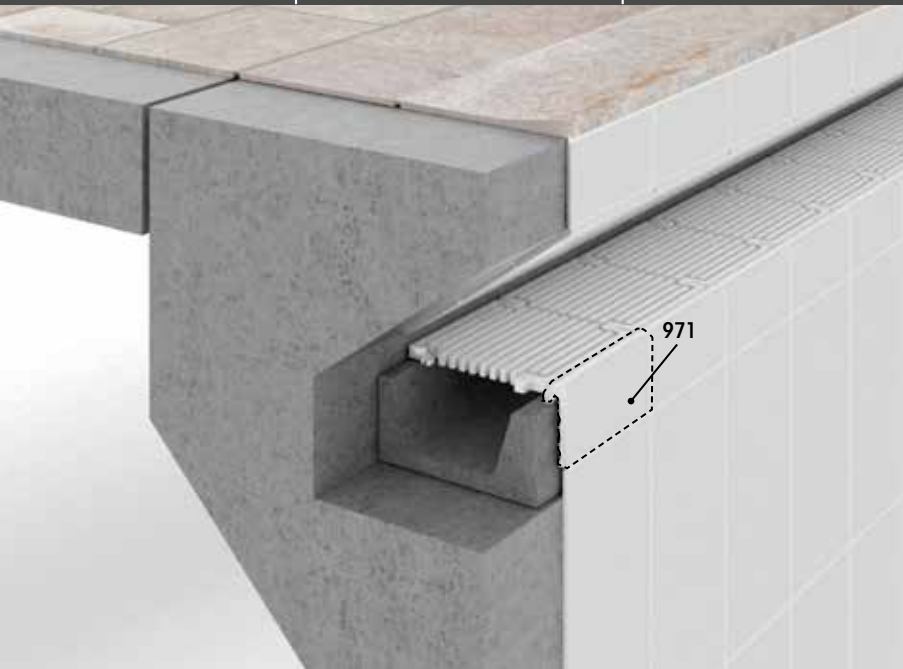



Sistema de pre-playa descendente solucionado con una sola pieza de 31 x 31 ó 31 x 62,6. Los bloques S9 proporcionan la pendiente y solucionan el apoyo de rejilla del rebosadero.

A downward-sloping pre-deck system comprised of a single 31 x 31 or 31 x 62.6 piece. S9 blocks provide the slope and support the overflow grate.

Système d'avant-plage descendante constitué d'une seule pièce de 31 x 31 ou 31 x 62,6. Les blocs S9 offrent la pente et servent d'appui pour la grille.

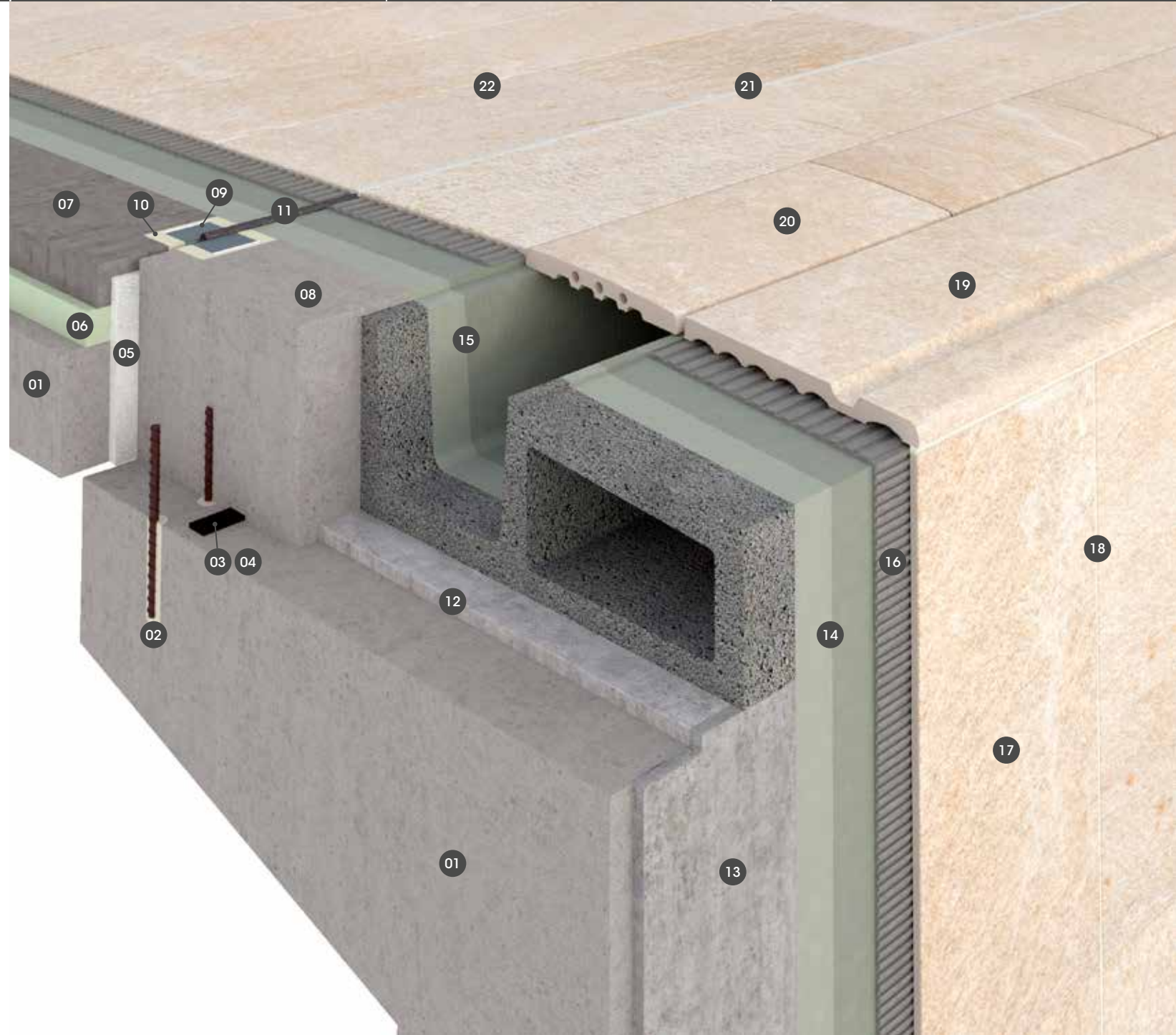

- 01 Estructura de hormigón del vaso  
Concrete structure of the tank  
Structure en béton de la piscine
- 02 **EPOXICOL**  
Mortero epoxi de anclaje  
Epoxy anchoring mortar  
Mortier époxy de calage
- 03 **FUGA-STOP MINI 20 x 10 mm**  
Junta hidro-expansiva  
Hydro-expanding waterstop  
Profilé d'étanchéité hydro-expansif
- 04 **MASTIC MS**  
Adhesivo para pegar la Fuga-Stop Mini  
Adhesive for sticking the Fuga-Stop Mini  
Adhésif pour coller le Fuga-Stop Mini
- 05 **POLIESTIRENO EXPANDIDO:**  
relleno de la junta de dilatación  
**EXPANDED POLYSTYRENE:**  
filling of the expansion joint  
**POLYSTYRÈNE EXPANSÉ:**  
remplissage du joint de dilatation
- 06 **POLIESTIRENO EXTRUSIONADO:**  
aislamiento térmico  
**EXTRUDED POLYSTYRENE:**  
thermal insulation  
**POLYSTYRÈNE EXTRUDÉ:**  
isolation thermique
- 07 **PAVIFORT**  
Mortero de recricado de las playas  
Pre-mixed mortar for screeds  
Mortier prêt à gâcher, pour la réalisation de chapes
- 08 Talón de hormigón posterior a las piezas S9  
Concrete wall behind the S9 pieces  
Mur de béton derrière les pièces S9
- 09 **FIX-TAPE 170 mm**  
Junta de dilatación elástica e impermeable  
Elastic and waterproof strip for expansion joints  
Bande élastique et imperméable pour les joints de dilatation
- 10 **EPOXICOL**  
Mortero epoxi adhesivo de la Fix-tape 170 mm  
Epoxy adhesive mortar for Fix-tape 170 mm  
Mortier-colle époxy pour Fix-tape 170 mm
- 11 **SELLALASTIC FOAM**  
Cordón elástico de relleno de la junta  
Closed cell to use as background filling in joints  
Profilé en polyéthylène à cellule fermée utilisée comme fond de joint
- 12 Mortero adhesivo de las piezas de S9 mejorado con Primfix  
Improved adhesive mortar with Primfix to fix S9 pieces  
Mortier amélioré avec Primfix pour fixer les pièces S9

- 13 **FIX-REVOCO**  
Mortero adhesivo para recricado de paredes  
Pre-mixed adhesive mortar for rendering walls  
Mortier prêt à gâcher, pour la réalisation de crépissages sur murs
- 14 **HIDROELASTIC**  
1ª y 2ª mano de la impermeabilización elástica  
1<sup>st</sup> and 2<sup>nd</sup> layer of elastic waterproofing  
1<sup>ère</sup> et 2<sup>de</sup> couche d'imperméabilisation élastique
- 15 **HIDROFIX**  
1ª y 2ª mano de impermeabilización flexible  
1<sup>st</sup> and 2<sup>nd</sup> layer of flexible waterproofing  
1<sup>ère</sup> et 2<sup>de</sup> couche d'imperméabilisation flexible
- 16 **TECNOCOL FLEX**  
Ultra-adhesivo para el pegado de la cerámica  
Maximum adherence glue-cement for sticking porcelain tiles  
Ciment colle flexible, à adhérence maximale pour la pose de grès cérame
- 17 **316 liso / anti-slip 31 x 62,6 x 0,9 cm Rosa Gres**  
Gres porcelánico  
Porcelain tile  
Grès cérame
- 18 **CERPOXI**  
Mortero de rejuntado epoxi anti-ácido  
100% impermeable  
Epoxy mortar, waterproof and acid proof for sealing joints.  
Époxy joint, extra fluide, imperméable et inattaquable par les acides
- 19 **647 anti-slip 62,6 x 31 x 2,6 cm Rosa Gres**  
Gres porcelánico  
Porcelain tile  
Grès cérame
- 20 **245 CM anti-slip 24,5 x 49,8 x 2,2 cm Rosa Gres**  
Rejilla Compact, gres porcelánico  
Compact Grid, porcelain tile  
Grille Compact, grès cérame
- 21 **SELLALASTIC**  
Masilla de poliuretano de máxima elasticidad  
Polyurethane filler of extraordinary elasticity  
Mastic polyuréthane d'une extraordinaire élasticité.
- 22 **JUNTATEC**  
Mortero de rejuntado resistente a los ácidos débiles  
Mortar for sealing resistant to slight chemical aggressions  
Mortier pour le scellement de joint, résistant aux légères agressions chimiques



Palcalm School, Barcelona, Spain  
Serena Bianco

Prestige | Con S9 | With S9 | Avec S9

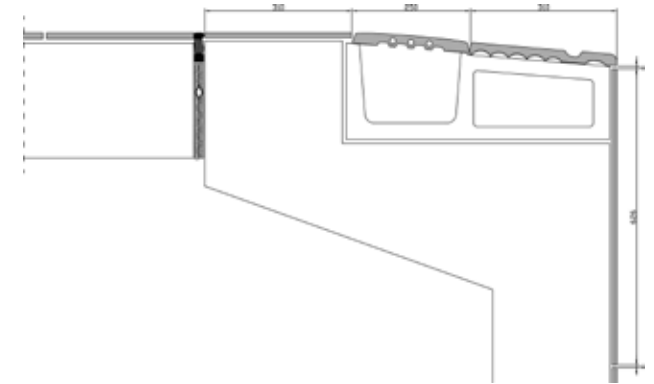

Prestige | Sin S9 | Without S9 | Sans S9

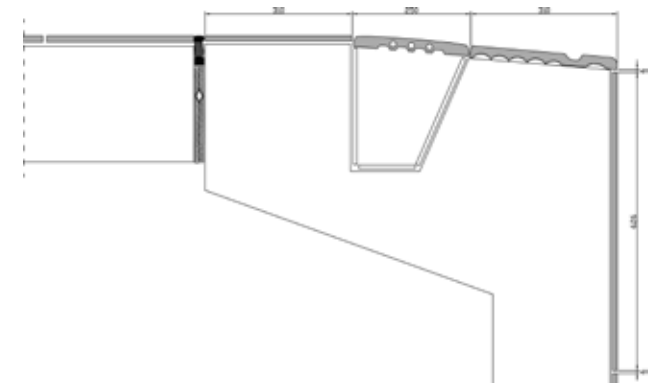



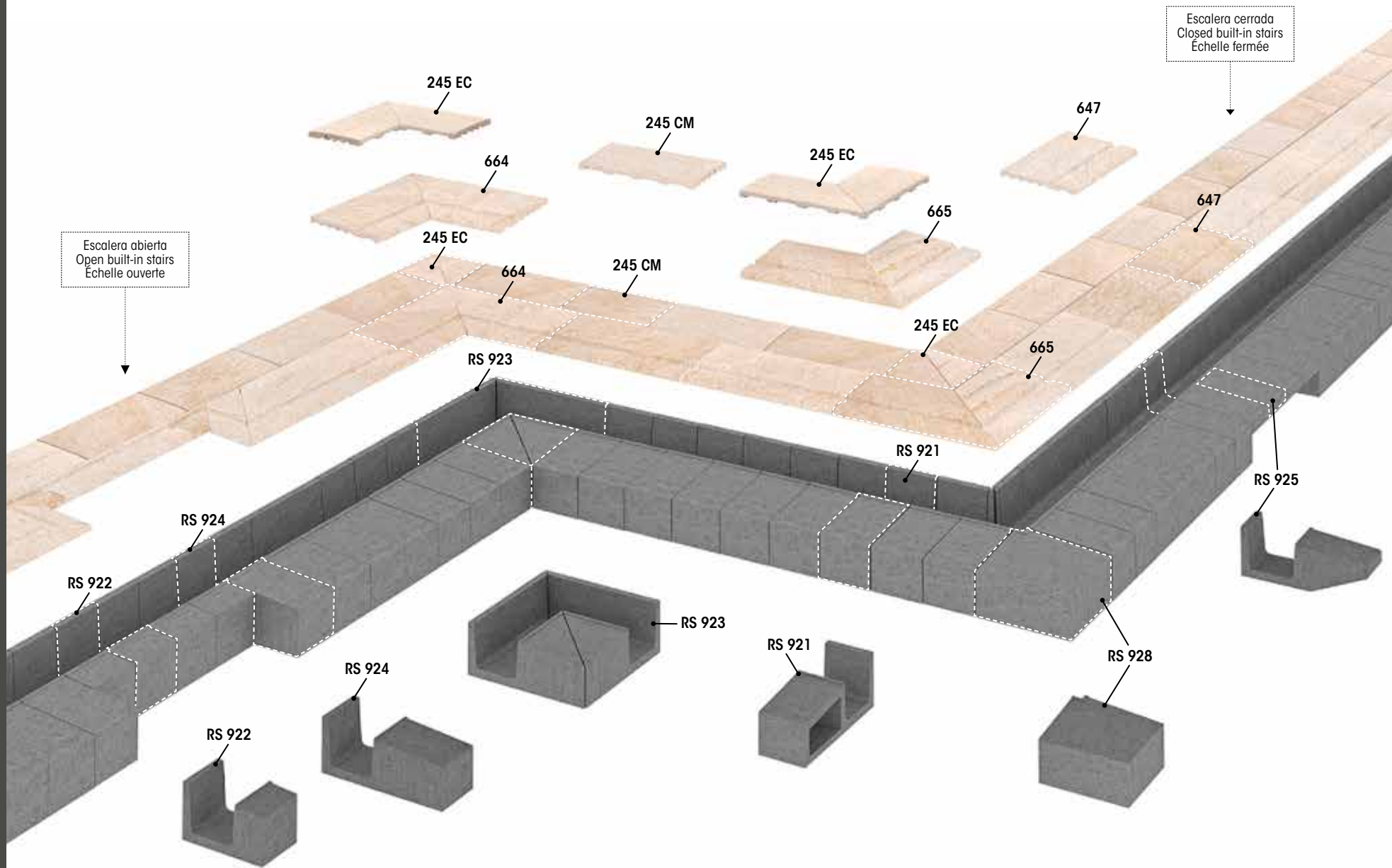

Rejilla | Grid | Grille |

### Compact

Piezas de borde y esquinas | Edging tiles and corners | Pièces de bord et angles

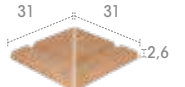
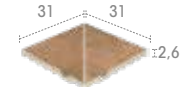
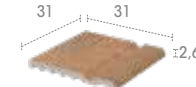
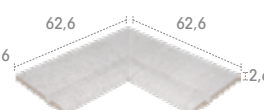
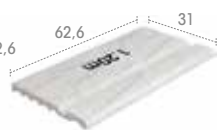
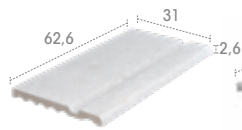
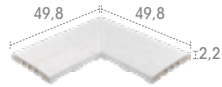
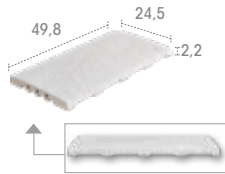
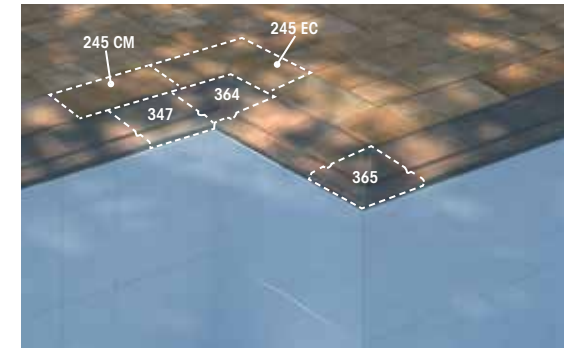
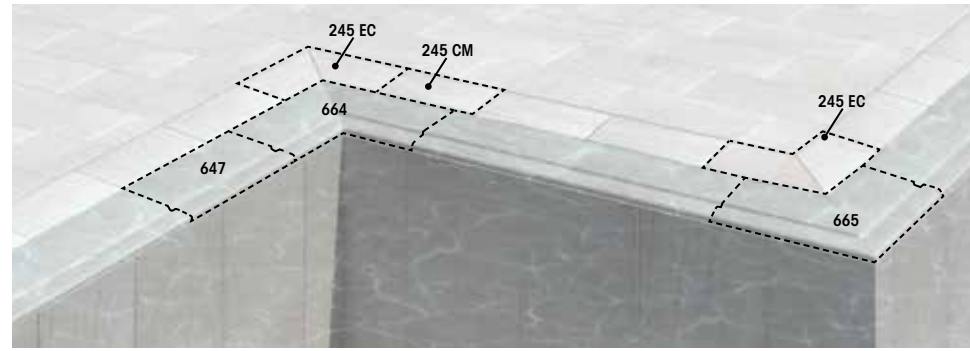
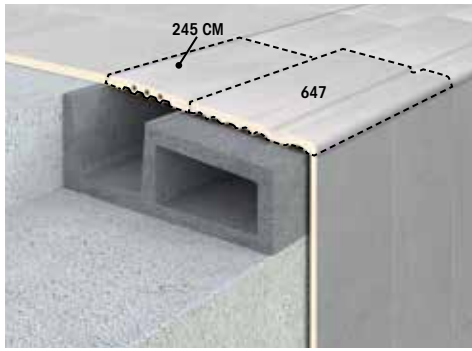

**245 CM**  
anti-slip

**245 EC**  
anti-slip

**647**  
anti-slip

**647 NU**  
anti-slip

**664**  
anti-slip

**665**  
anti-slip

**347**  
anti-slip

**364**  
anti-slip

**365**  
anti-slip



(1) Solo Ref. 245 CM y 245 EC / Ref. 245 CM and 245 EC only / Seulement Ref. 245 CM et 245 EC

### Bloques S9 | S9 Blocks | Modules S9

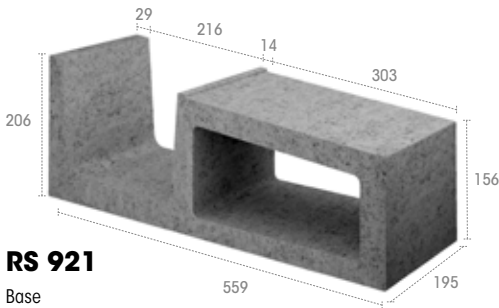

**RS 921**

Base

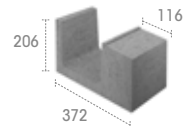

**RS 922**

Escalera abierta  
Open built-in stairs  
Échelle ouverte

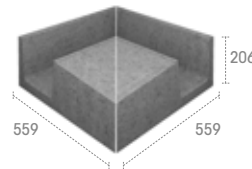

**RS 923**

Esquina Interior  
Inside corner  
Angle intérieur

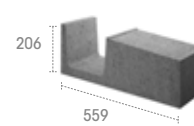

**RS 924**

Maciza  
Solid  
Solide

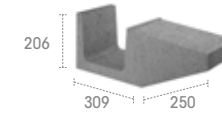

**RS 925**

Escalera cerrada  
Closed built-in stairs  
Échelle fermée

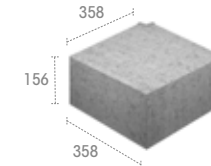

**RS 928**

Esquina Exterior  
Outside corner  
Angle extérieur



Rejilla | Grid | Grille  
**Flex**

PRESTIGE

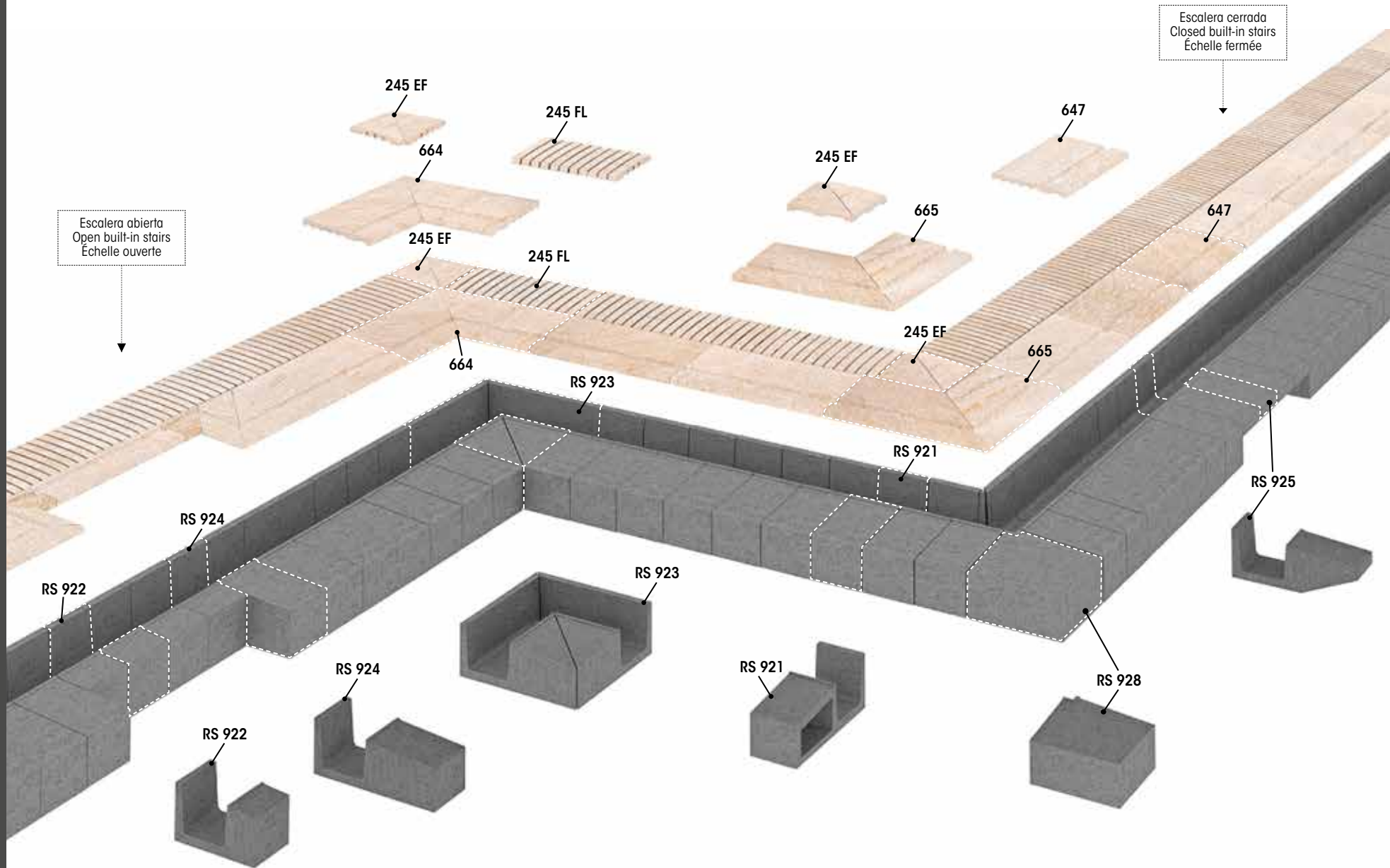

Escalera abierta  
Open built-in stairs  
Échelle ouverte

Escalera cerrada  
Closed built-in stairs  
Échelle fermée

Rejilla | Grid | Grille |

### Flex

Piezas de borde y esquinas | Edging tiles and corners | Pièces de bord et angles

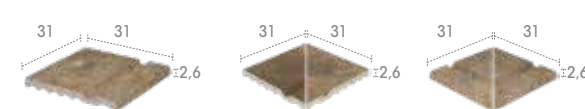
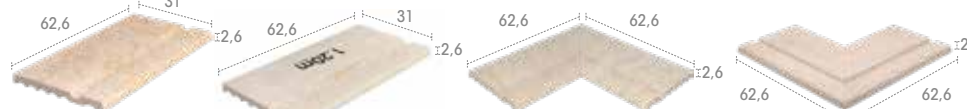
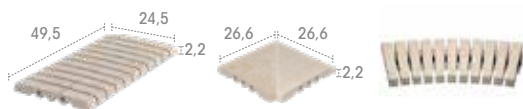
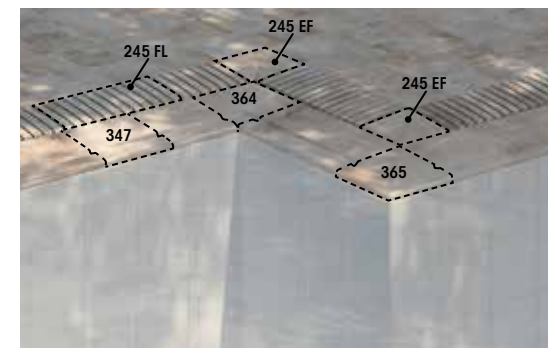
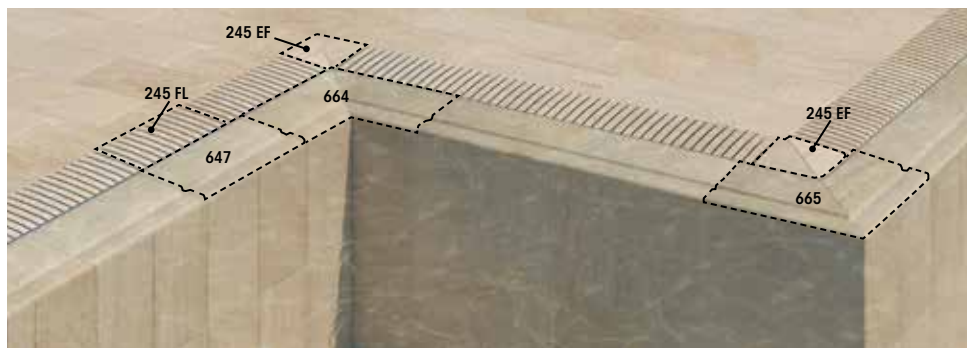
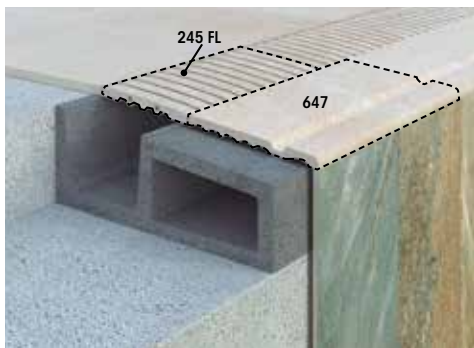

**245 FL**  
anti-slip

**245 EF**  
anti-slip

**245 RS**  
anti-slip

**647**  
anti-slip

**647 NU**  
anti-slip

**664**  
anti-slip

**665**  
anti-slip

**347**  
anti-slip

**364**  
anti-slip

**365**  
anti-slip



(1) Solo Ref. 245 FL y 245 EF / Ref. 245 FL and 245 EF only / Seulement Ref. 245 FL et Ref. 245 EF

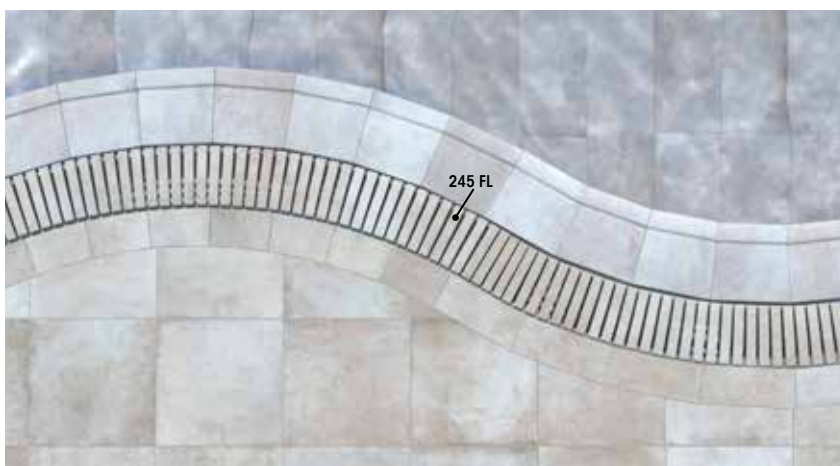

### 245 FL

Permite realizar curvas a partir de un radio de 75 cm.

It can be used to create curves with a radius of more than 75 cm.

Permet de réaliser des formes libres à partir d'un rayon de 75 cm.

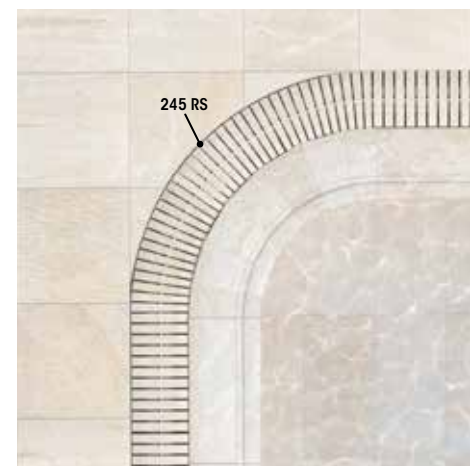

### 245 RS

Permite realizar curvas con un radio menor a 75 cm.

It can be used to create curves with a radius of up to 75 cm.

Grille spéciale pour un rayon inférieur a 75 cm.





Club Hotel Miramar Obzor, Bulgaria  
*Rejilla Flex / Flex Grid / Grille Flex / Serena Mix*



Hotel Slavey Golden Sands, Bulgaria  
*Rejilla Compact / Compact Grid / Grille Compact / Mistery Grey*



Club Hotel Miramar Obzor, Bulgaria  
*Rejilla Flex / Flex Grid / Grille Flex / Serena Mix*

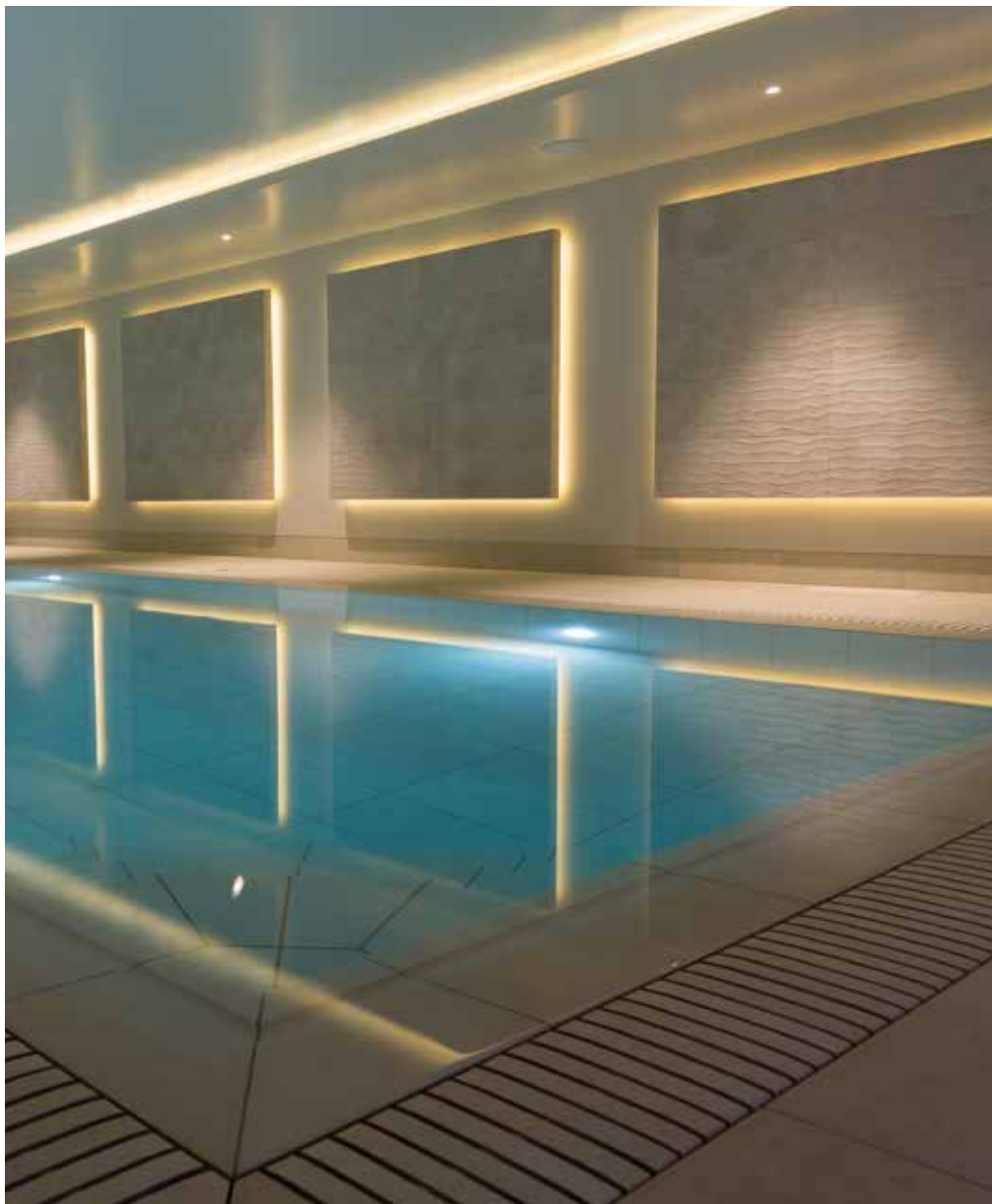

Private pool  
Rejilla Flex / Flex Grid / Grille Flex / Mistery White



Hotel Hilton Spa, Iasi, Romania  
Rejilla Flex / Flex Grid / Grille Flex / Lovely Dolce



Es el sistema tradicional con el que se construyen la mayoría de piscinas privadas. El nivel del agua está por debajo del nivel de playa (unos 20 cm). El agua se filtra por un solo punto o skimmer.

Most private swimming pools are built with this system. The water level lies about 20 cm below the pool rim; the pool water is filtered through an opening or skimmer.

La plupart des piscines particulières sont construites avec ce système. Le niveau de l'eau se situe à environ 20 cm de la margelle; l'eau est filtrée par un orifice, le skimmer.



- 01 Estructura de hormigón del vaso  
Concrete structure of the tank  
Structure en béton de la piscine
- 02 **POLIESTIRENO EXPANDIDO:**  
relleno de la junta de dilatación  
**EXPANDED POLYSTYRENE:**  
filling of the expansion joint  
**POLYSTYRÈNE EXPANSÉ:**  
remplissage du joint de dilatation
- 03 **POLIESTIRENO EXTRUSIONADO:**  
aislamiento térmico  
**EXTRUDED POLYSTYRENE:**  
thermal insulation  
**POLYSTYRÈNE EXTRUDÉ:**  
isolation thermique
- 04 **PAVIFORT**  
Mortero de recrecido de las playas  
Pre-mixed mortar for screeds  
Mortier prêt à gâcher, pour la réalisation de chapes
- 05 **FIX-TAPE 170 mm**  
Junta de dilatación elástica e impermeable  
Elastic and waterproof strip for expansion joints  
Bande élastique et imperméable pour les joints de dilatation
- 06 **EPOXICOL**  
Mortero epoxi adhesivo de la Fix-tape 170 mm  
Epoxy adhesive mortar for Fix-tape 170 mm  
Mortier-colle époxy pour Fix-tape 170 mm
- 07 **SELLALASTIC FOAM**  
Cordón elástico de relleno de la junta  
Closed cell to use as background filling in joints  
Profilé en polyéthylène à cellule fermée utilisée comme fond de joint
- 08 **FIX-REVOCO**  
Mortero adhesivo para recrecido de paredes  
Pre-mixed adhesive mortar for rendering walls  
Mortier prêt à gâcher, pour la réalisation de crépissages sur murs
- 09 **HIDROELASTIC**  
1ª y 2ª mano de la impermeabilización elástica  
1<sup>st</sup> and 2<sup>nd</sup> layer of elastic waterproofing  
1<sup>ère</sup> et 2<sup>de</sup> couche d'imperméabilisation élastique
- 10 **TECNOCOL FLEX**  
Ultra-adhesivo para el pegado de la cerámica  
Maximum adherence glue-cement for sticking porcelain tiles  
Ciment colle flexible, à adhérence maximale pour la pose de grès cérame
- 11 **316 liso / anti-slip 31 x 62,6 x 0,9 cm Rosa Gres**  
Gres porcelánico  
Porcelain tile  
Grès cérame

- 12 **CERPOXI**  
Mortero de rejunado epoxi anti-ácido  
100% impermeable  
Epoxy mortar, waterproof and acid proof for sealing joints  
Époxy joint, extra fluide, imperméable et inattaquable par les acides
- 13 **L62 anti-slip 62,6 x 31,7 x 3,8 cm Rosa Gres**  
Gres porcelánico  
Porcelain tile  
Grès cérame
- 14 **316 anti-slip 31 x 62,6 x 0,9 cm Rosa Gres**  
Gres porcelánico  
Porcelain tile  
Grès cérame
- 15 **SELLALASTIC**  
Masilla de poliuretano de máxima elasticidad  
Polyurethane filler of extraordinary elasticity  
Mastic polyuréthane d'une extraordinaire élasticité
- 16 **JUNTATEC**  
Mortero de rejunado resistente a los ácidos débiles  
Mortar for sealing resistant to slight chemical aggressions  
Mortier pour le scellement de joint, résistant aux légères agressions chimiques

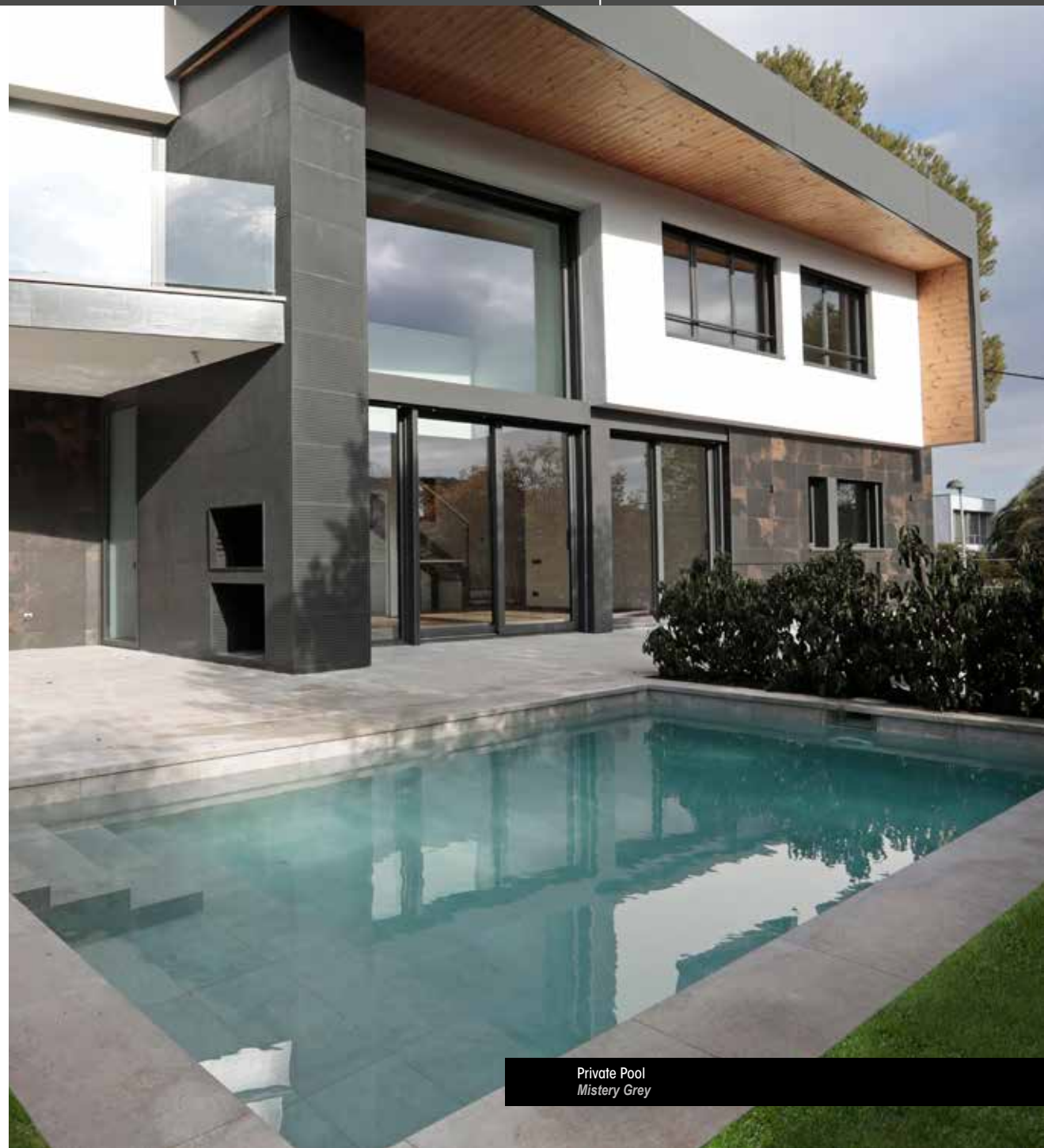
Private Pool  
Mystery Grey



Piezas de borde | Edging tiles | Pièces de bord

Esquinas | Corners | Angles

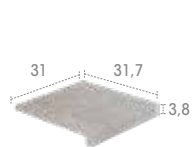
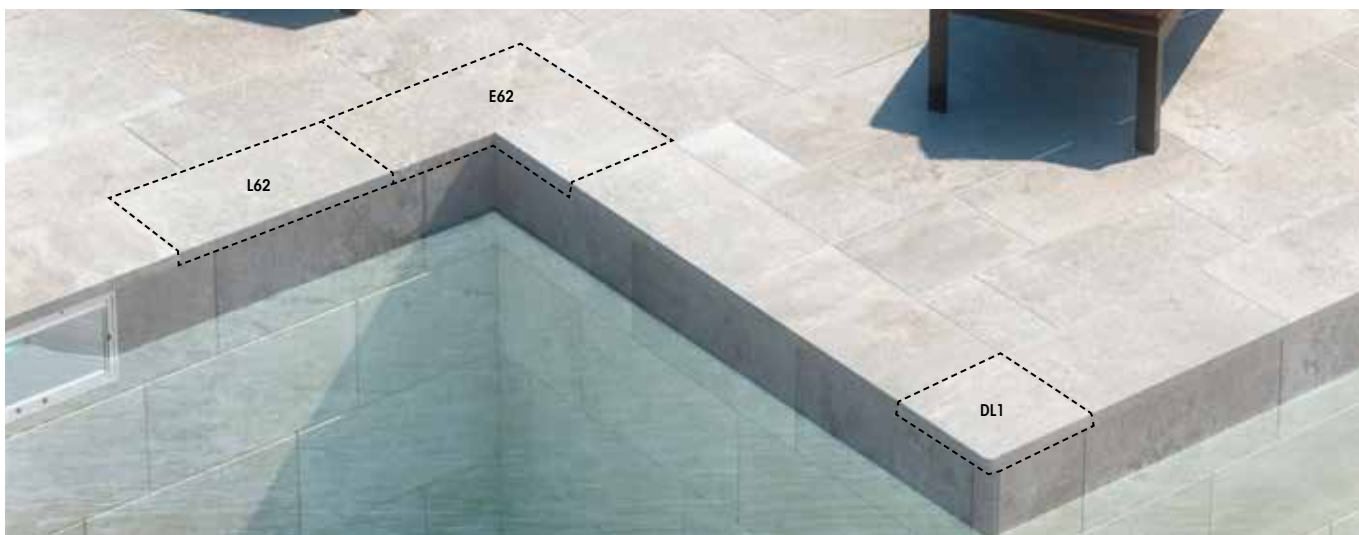

**L31**  
anti-slip



**L62**  
anti-slip

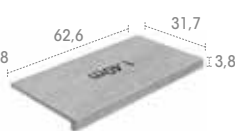

**L62 NU**  
anti-slip



**L98**  
anti-slip



**LM2**  
anti-slip

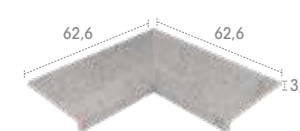

**E62**  
anti-slip

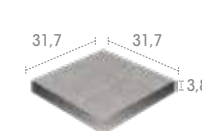

**DL1**  
anti-slip

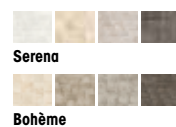

Esquinas | Corners | Angles

Piezas de borde | Edging tiles | Pièces de bord

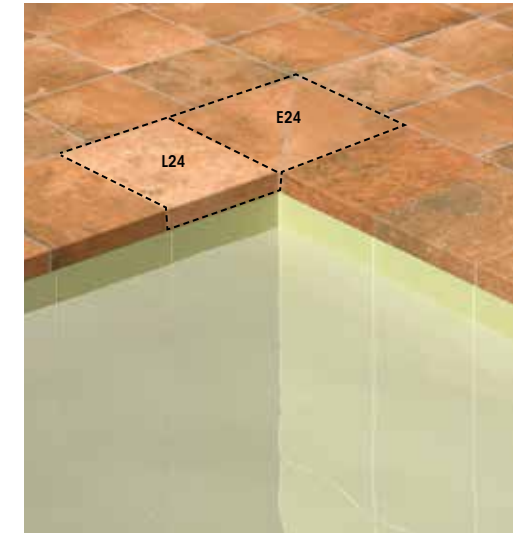
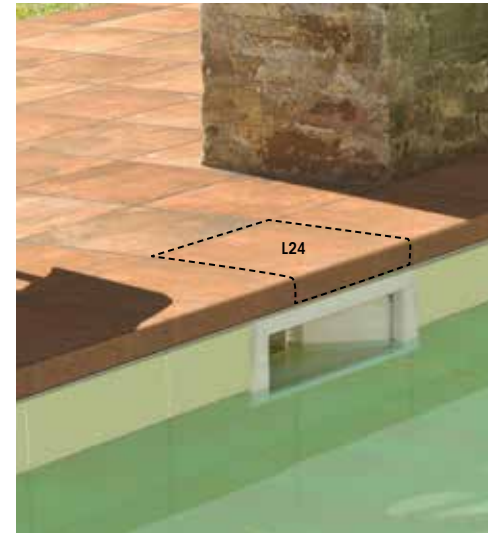
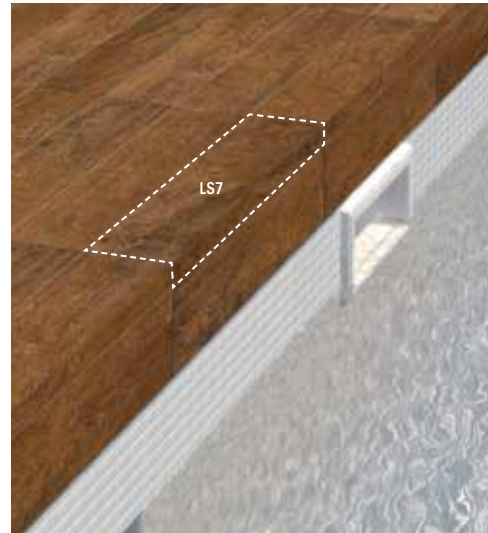
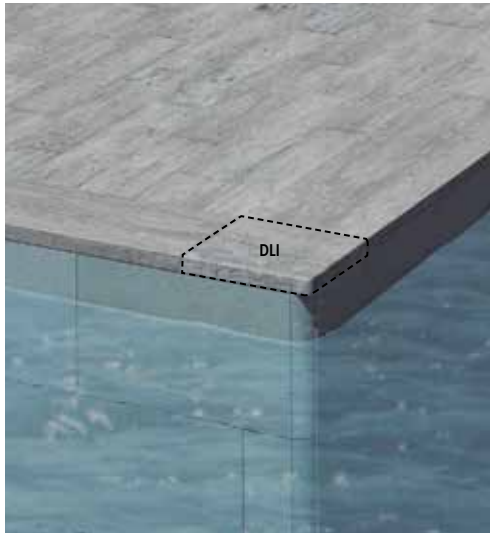

**DLI**  
anti-slip

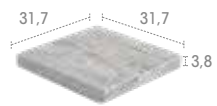

**DLD**  
anti-slip



**LS7**  
anti-slip

Peldaño ingleteado  
Mitred stair tread  
Nez de marche biseauté-colé

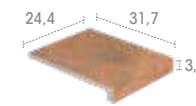

**L24**  
anti-slip

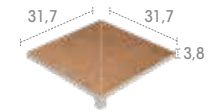

**E24**  
anti-slip



Lovely



Garden



Es el sistema tradicional con el que se construyen la mayoría de piscinas privadas. El nivel del agua está por debajo del nivel de playa (unos 20 cm). El agua se filtra por un solo punto o skimmer.

Most private swimming pools are built with this system. The water level lies about 20 cm below the pool edge; the pool water is filtered through an opening or skimmer.

La plupart des piscines particulières sont construites avec ce système. Le niveau de l'eau se situe à environ 20 cm de la margelle; l'eau est filtrée par un orifice, le skimmer.

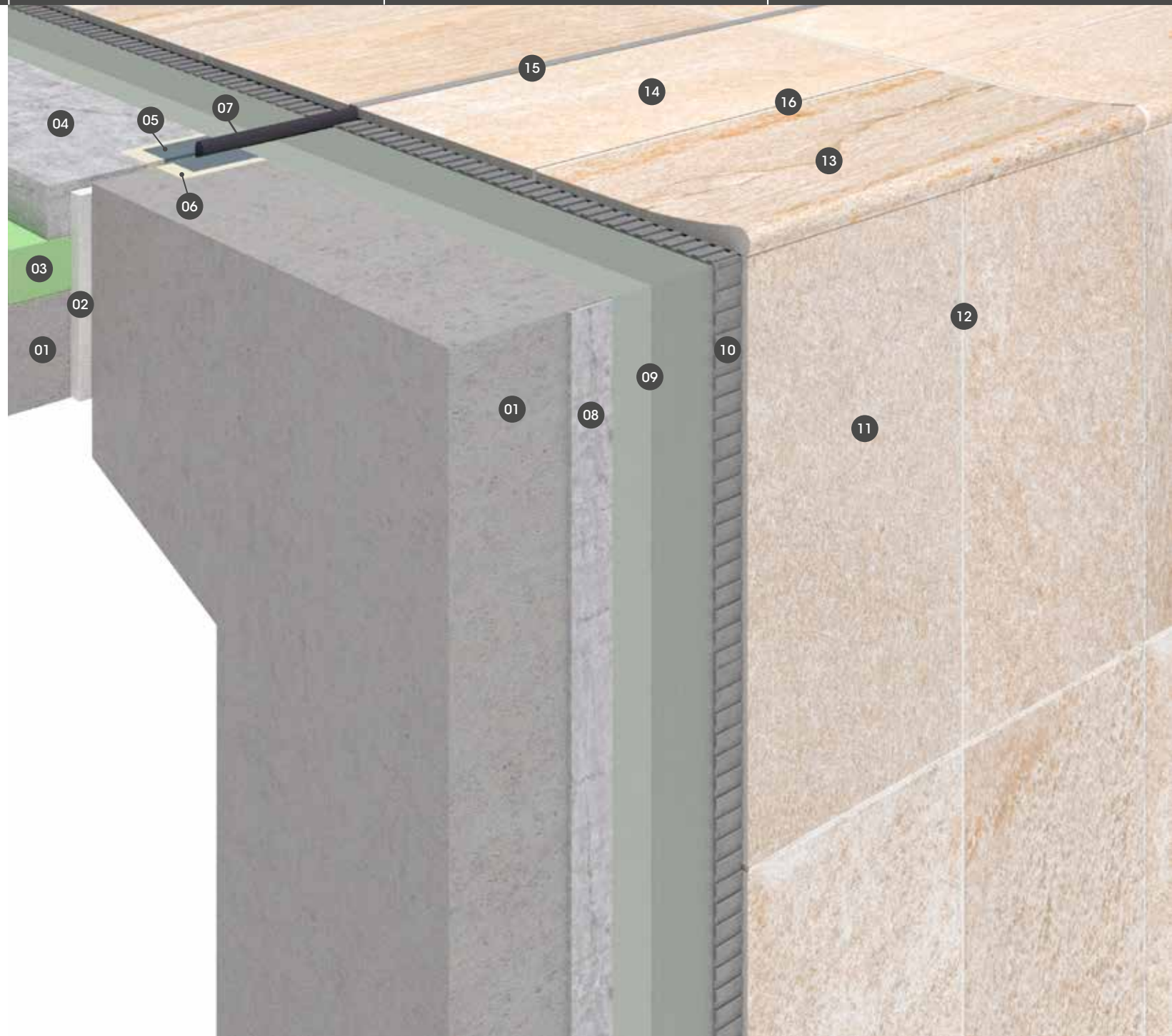

- 01 Estructura de hormigón del vaso  
Concrete structure of the tank  
Structure en béton de la piscine
- 02 **POLIESTIRENO EXPANDIDO:**  
relleno de la junta de dilatación  
**EXPANDED POLYSTYRENE:**  
filling of the expansion joint  
**POLYSTYRÈNE EXPANSÉ:**  
remplissage du joint de dilatation
- 03 **POLIESTIRENO EXTRUSIONADO:**  
aislamiento térmico  
**EXTRUDED POLYSTYRENE:**  
thermal insulation  
**POLYSTYRÈNE EXTRUDÉ:**  
isolation thermique
- 04 **PAVIFORT**  
Mortero de recocado de las playas  
Pre-mixed mortar for screeds  
Mortier prêt à gâcher, pour la réalisation de chapes
- 05 **FIX-TAPE 170 mm**  
Junta de dilatación elástica e impermeable  
Elastic and waterproof strip for expansion joints  
Bande élastique et imperméable pour les joints de dilatation
- 06 **EPOXICOL**  
Mortero epoxi adhesivo de la Fix-tape 170 mm  
Epoxy adhesive mortar for Fix-tape 170 mm  
Mortier-colle époxy pour Fix-tape 170 mm
- 07 **SELLALASTIC FOAM**  
Cordón elástico de relleno de la junta  
Closed cell to use as background filling in joints  
Profilé en polyéthylène à cellule fermée utilisée comme fond de joint
- 08 **FIX-REVOCO**  
Mortero adhesivo para recocado de paredes  
Pre-mixed adhesive mortar for rendering walls  
Mortier prêt à gâcher, pour la réalisation de crépissages sur murs
- 09 **HIDROELASTIC**  
1ª y 2ª mano de la impermeabilización elástica  
1<sup>st</sup> and 2<sup>nd</sup> layer of elastic waterproofing  
1<sup>ère</sup> et 2<sup>de</sup> couche d'imperméabilisation élastique
- 10 **TECNOCOL FLEX**  
Ultra-adhesivo para el pegado de la cerámica  
Maximum adherence glue-cement for sticking porcelain tiles  
Ciment colle flexible, à adhérence maximale pour la pose de grès cérame
- 11 **316 liso / anti-slip 31 x 62,6 x 0,9 cm Rosa Gres**  
Gres porcelánico  
Porcelain tile  
Grès cérame

- 12 **CERPOXI**  
Mortero de rejuntable epoxi anti-ácido  
100% impermeable  
Epoxy mortar, waterproof and acid proof for sealing joints  
Époxy joint, extra fluide, imperméable et inattaquable par les acides
- 13 **S62 anti-slip 62,6 x 31 x 2,6 cm Rosa Gres**  
Gres porcelánico  
Porcelain tile  
Grès cérame
- 14 **316 anti-slip 31 x 62,6 x 0,9 cm Rosa Gres**  
Gres porcelánico  
Porcelain tile  
Grès cérame
- 15 **SELLALASTIC**  
Masilla de poliuretano de máxima elasticidad  
Polyurethane filler of extraordinary elasticity  
Mastic polyuréthane d'une extraordinaire élasticité
- 16 **JUNTATEC**  
Mortero de rejuntable resistente a los ácidos débiles  
Mortar for sealing resistant to slight chemical aggressions  
Mortier pour le scellement de joint, résistant aux légères agressions chimiques

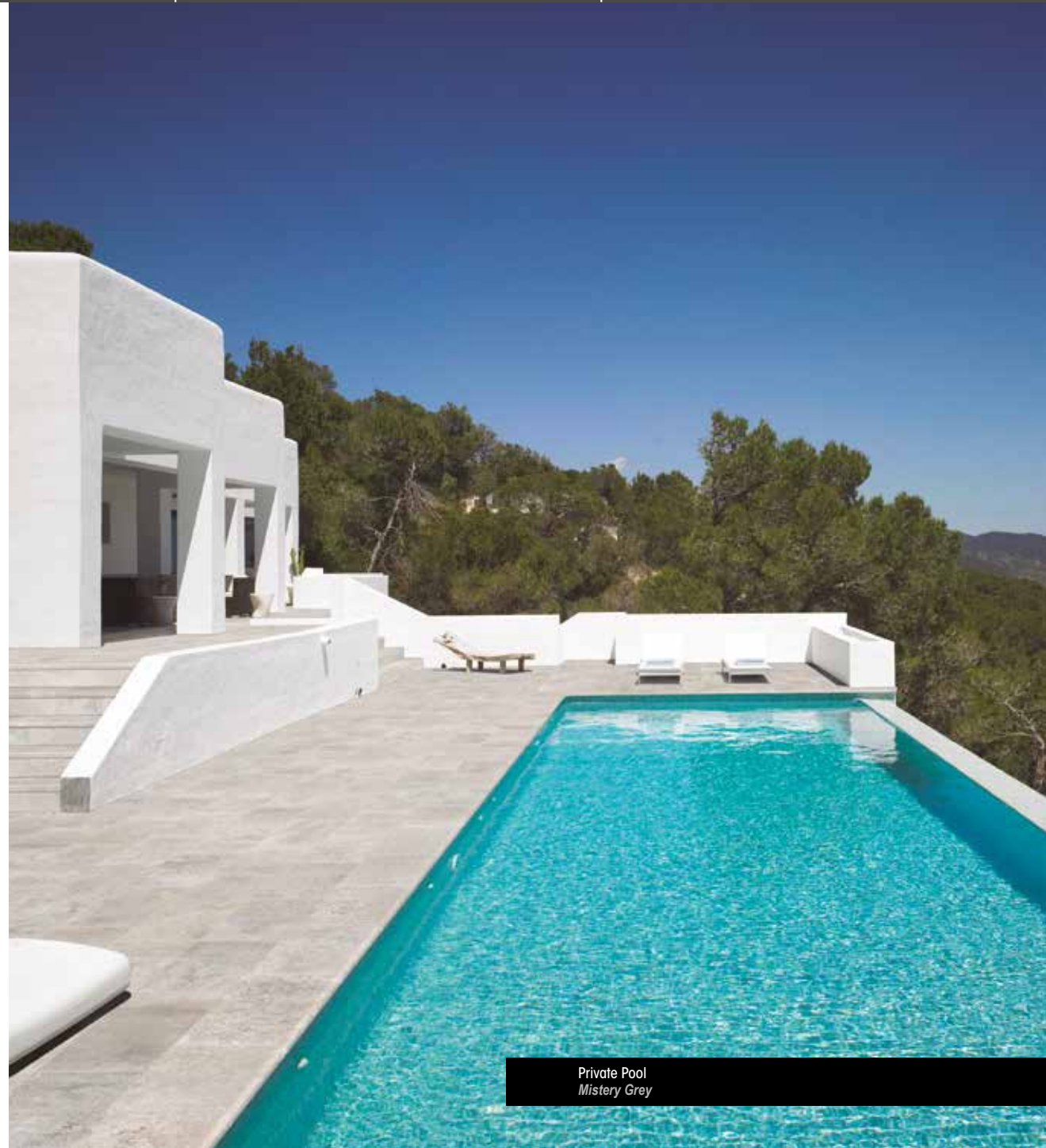
Private Pool  
Mystery Grey



Piezas de borde | Edging tiles | Pièces de bord

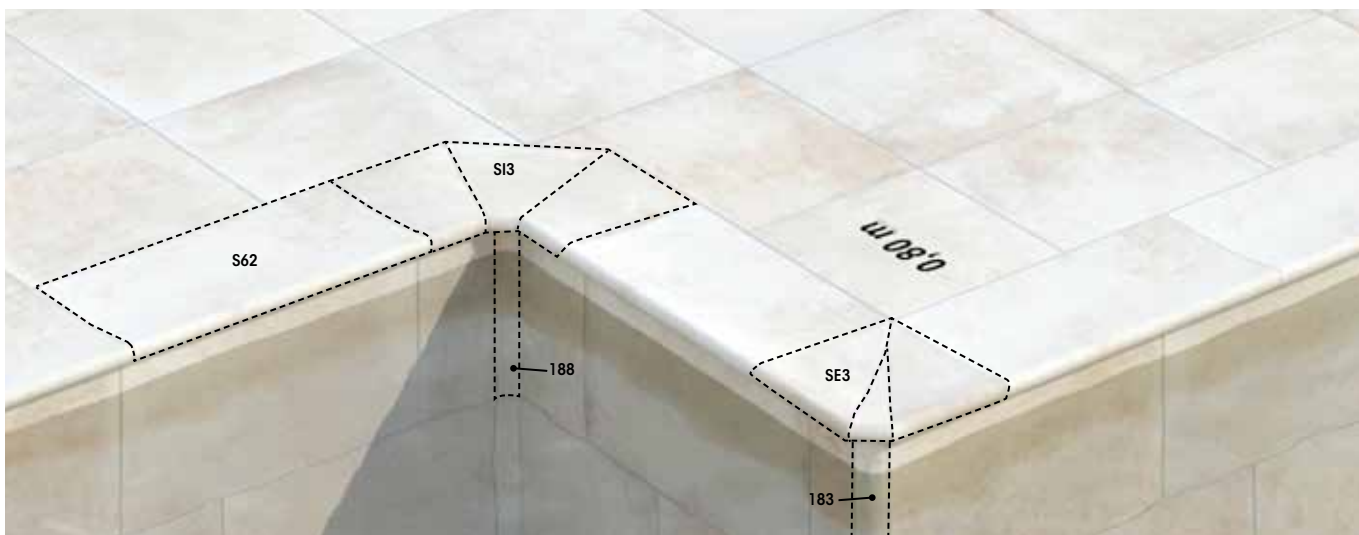

Medias cañas | Half round pieces | Demi-cannes

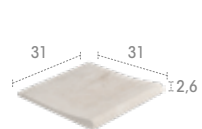
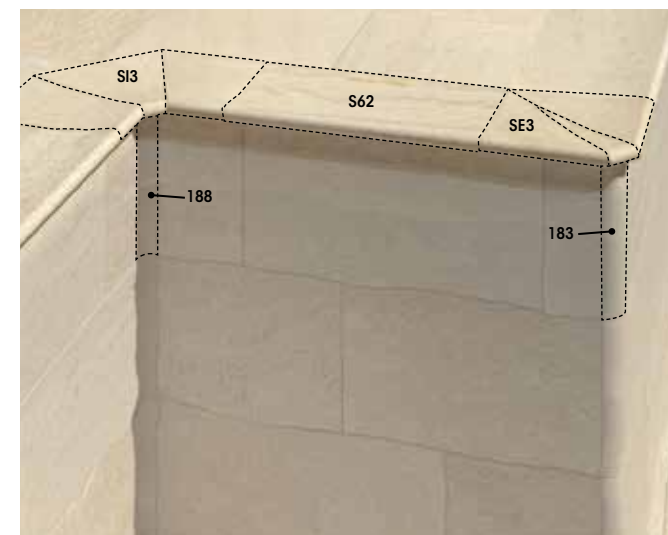

**S31**

anti-slip

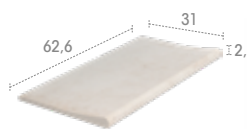

**S62**

anti-slip



**S62 NU**

anti-slip

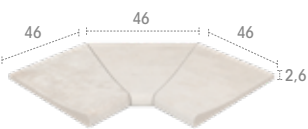

**S13**

anti-slip



**SE3**

anti-slip



**188**

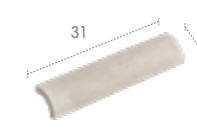

**183**

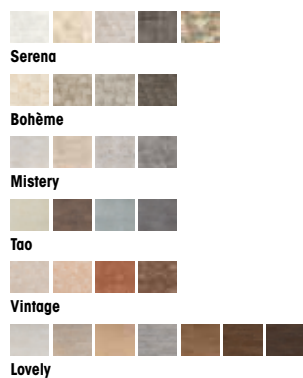



Private pool  
*Lovely Intense*

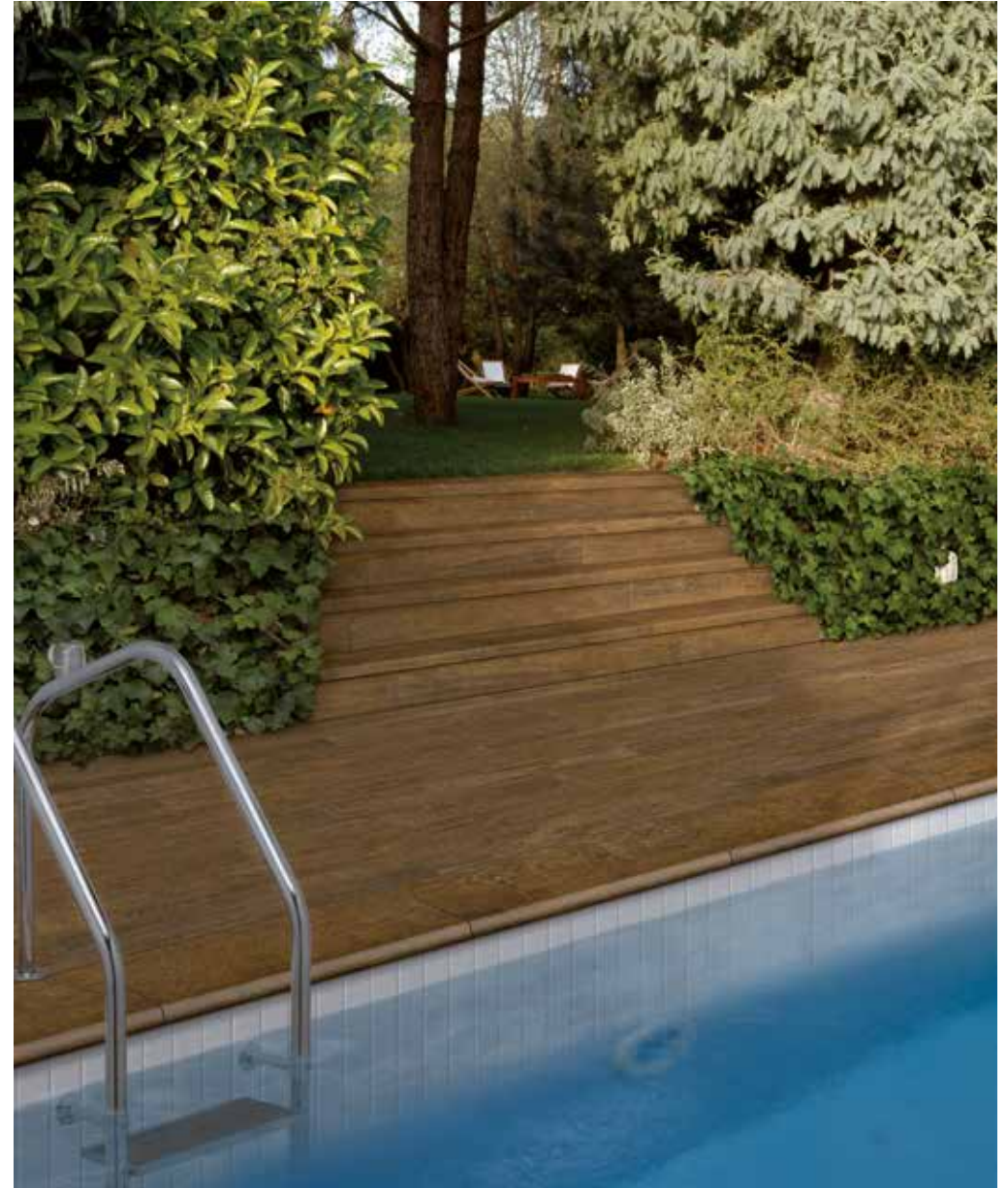

Private pool  
*Lovely Vital*





**244 G1**

liso / anti-slip  
24,4 x 49,4 x 0,8  
9<sup>1</sup>/<sub>2</sub>" x 19<sup>1</sup>/<sub>2</sub>"

**122 G1**

liso / anti-slip  
11,9 x 24,4 x 0,8  
4<sup>1</sup>/<sub>2</sub>" x 9<sup>1</sup>/<sub>2</sub>"

**052 G1**

liso  
5,6 x 24,4 x 0,8  
2" x 9<sup>1</sup>/<sub>2</sub>"

Para vasos de piscinas infantiles, consulte con nuestro departamento técnico que acabado es el más adecuado.

Please consult our technical department about the most suitable finish for children's play areas and swimming pools.

N'hésitez pas à contacter notre service technique afin d'en savoir plus sur nos finitions de piscines et aires de jeux les plus adaptées pour les enfants.



Zsóry Thermal & Spa, Mezőkövesd, Hungary / Sáth És Társa Építész Irona Architect  
Blanco / Azul



### Medias cañas | Half-round pieces | Demi-cannes

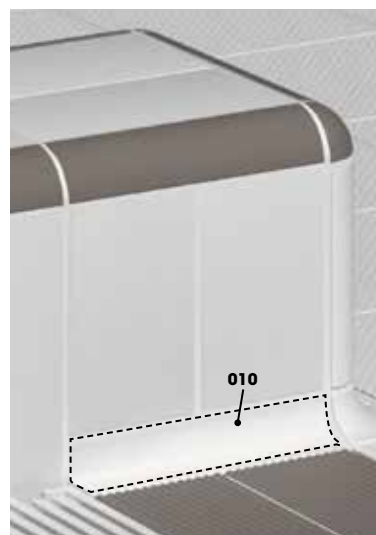
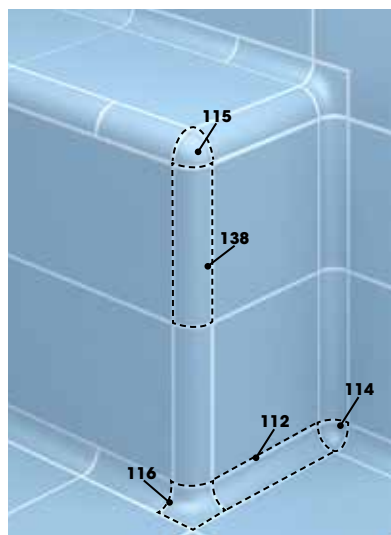
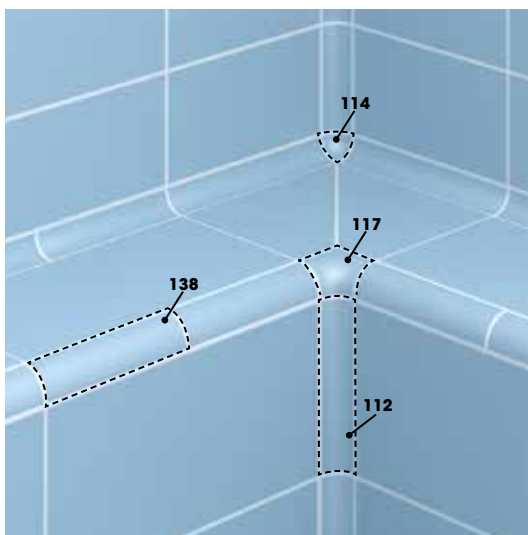

**138** liso / anti-slip  
**115** liso / anti-slip  
**117** liso / anti-slip



**112** liso  
**114** liso  
**116** liso  
**010** liso



(1) Solo anti-slip  
(1) Anti-slip only  
(1) Seulement anti-slip



(2) Solo Ref. 112  
(2) Ref. 112 only  
(2) Seulement Ref. 112

### Piezas estriadas | Grooved tiles | Pièces striées

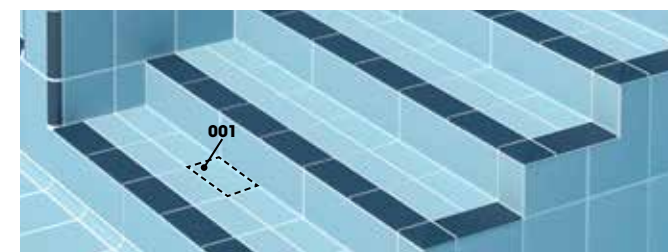
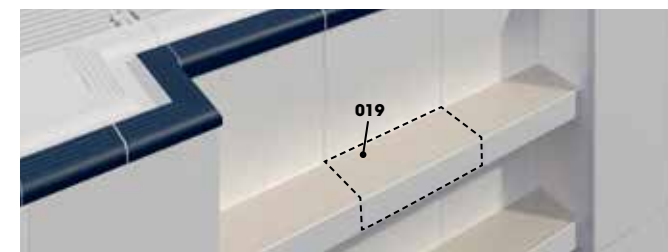

**001** anti-slip  
**019** anti-slip

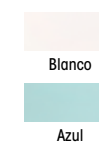

Romo | Bullnose | Arrondi

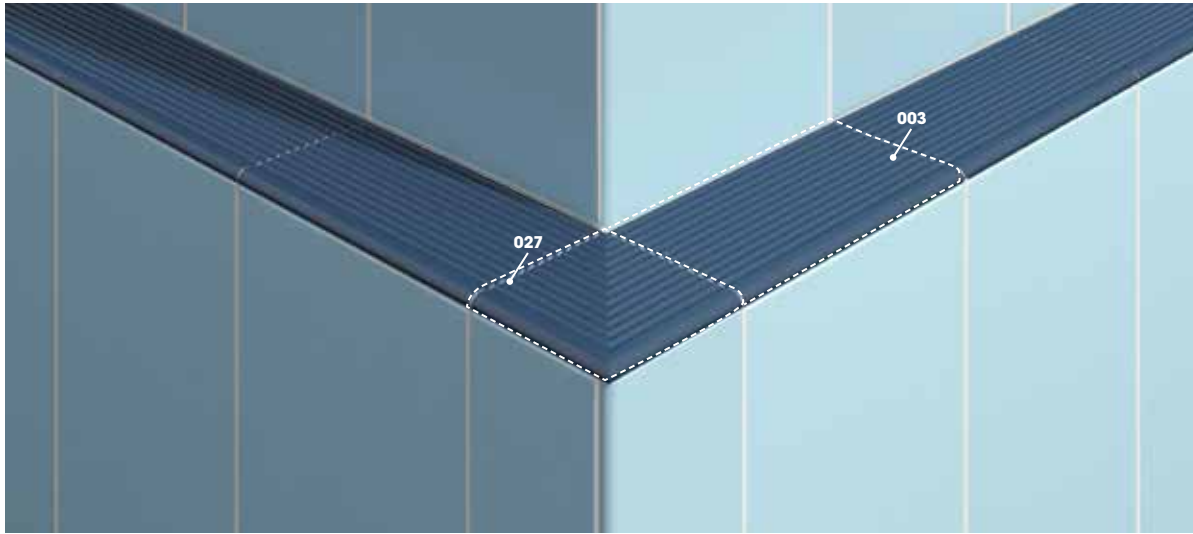

Núm. de profundidad | Depth tiles | Num. de profondeur



<b>413</b> liso	<b>013</b> liso / anti-slip	<b>009</b> liso / anti-slip	<b>003</b> anti-slip	<b>027</b> anti-slip	<b>122 N9</b> liso / anti-slip	<b>122 P9</b> liso / anti-slip	<b>122 PO/122 P8</b> liso	<b>190/198</b> liso																							
<table border="0"> <tr><td>Blanco</td><td>Azul</td></tr> <tr><td>Marino</td><td>Caramel</td></tr> <tr><td>Acero</td><td>Plomo</td></tr> </table>	Blanco	Azul	Marino	Caramel	Acero	Plomo	<table border="0"> <tr><td>Blanco</td><td>Azul</td></tr> <tr><td>Marino</td><td>Caramel</td></tr> <tr><td>Acero</td><td>Plomo</td></tr> <tr><td>Indubeige</td><td></td></tr> </table>	Blanco	Azul	Marino	Caramel	Acero	Plomo	Indubeige		<table border="0"> <tr><td>Blanco</td></tr> <tr><td>Azul</td></tr> </table>	Blanco	Azul	<table border="0"> <tr><td>Blanco</td><td>Azul</td></tr> <tr><td>Marino</td><td>Indubeige</td></tr> </table>	Blanco	Azul	Marino	Indubeige	<table border="0"> <tr><td>Marino</td></tr> </table>	Marino	<table border="0"> <tr><td>Blanco</td></tr> <tr><td>Azul</td></tr> </table>				Blanco	Azul
Blanco	Azul																														
Marino	Caramel																														
Acero	Plomo																														
Blanco	Azul																														
Marino	Caramel																														
Acero	Plomo																														
Indubeige																															
Blanco																															
Azul																															
Blanco	Azul																														
Marino	Indubeige																														
Marino																															
Blanco																															
Azul																															



Cama de agua y escalera | Water bed and stairs | Banquette et escalier

## Ergo

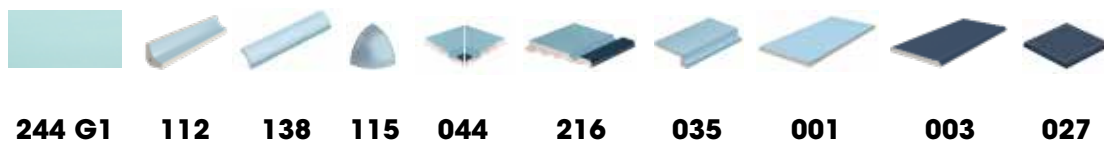
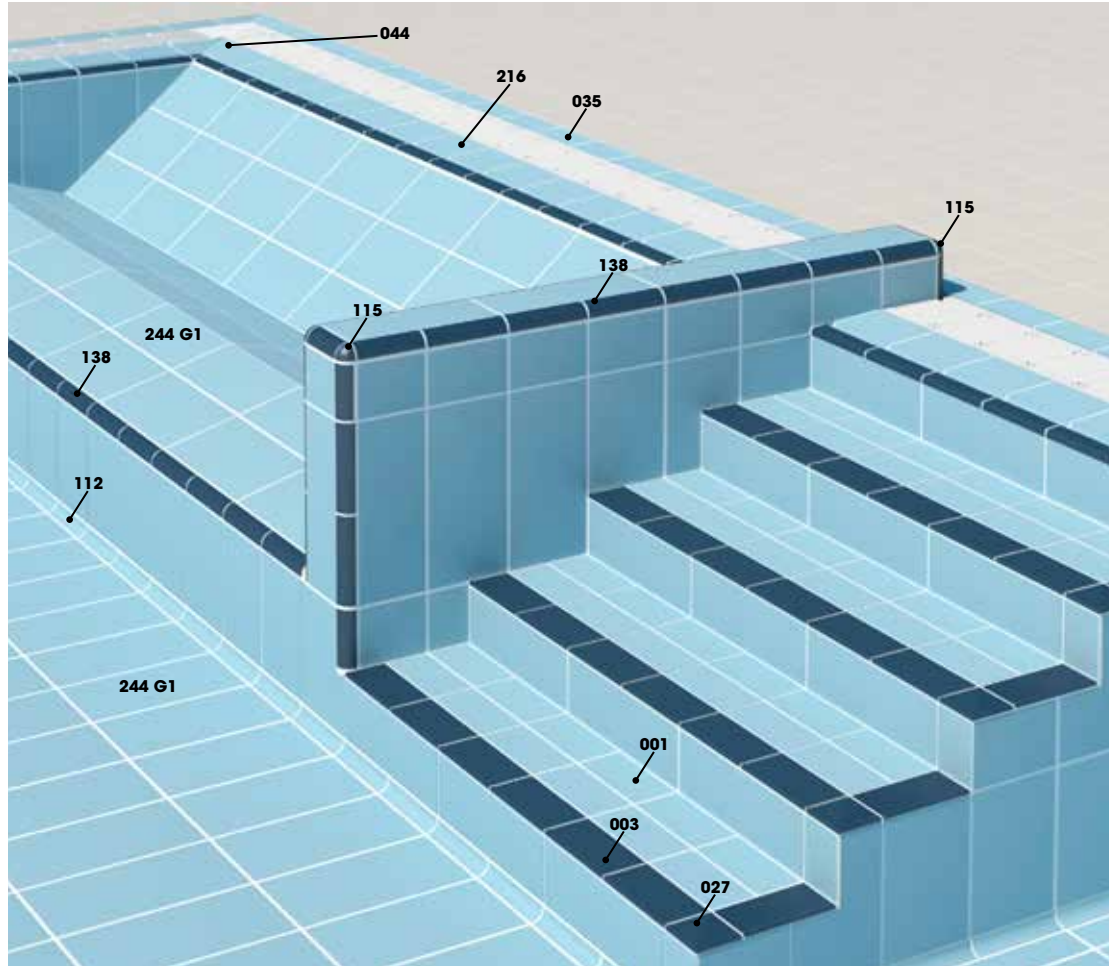

Murete y escalera cerrada | Headwall for podiums and closed stairs | Muret et échelle fermée

## Horizon

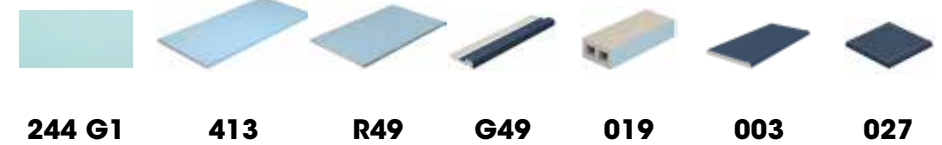
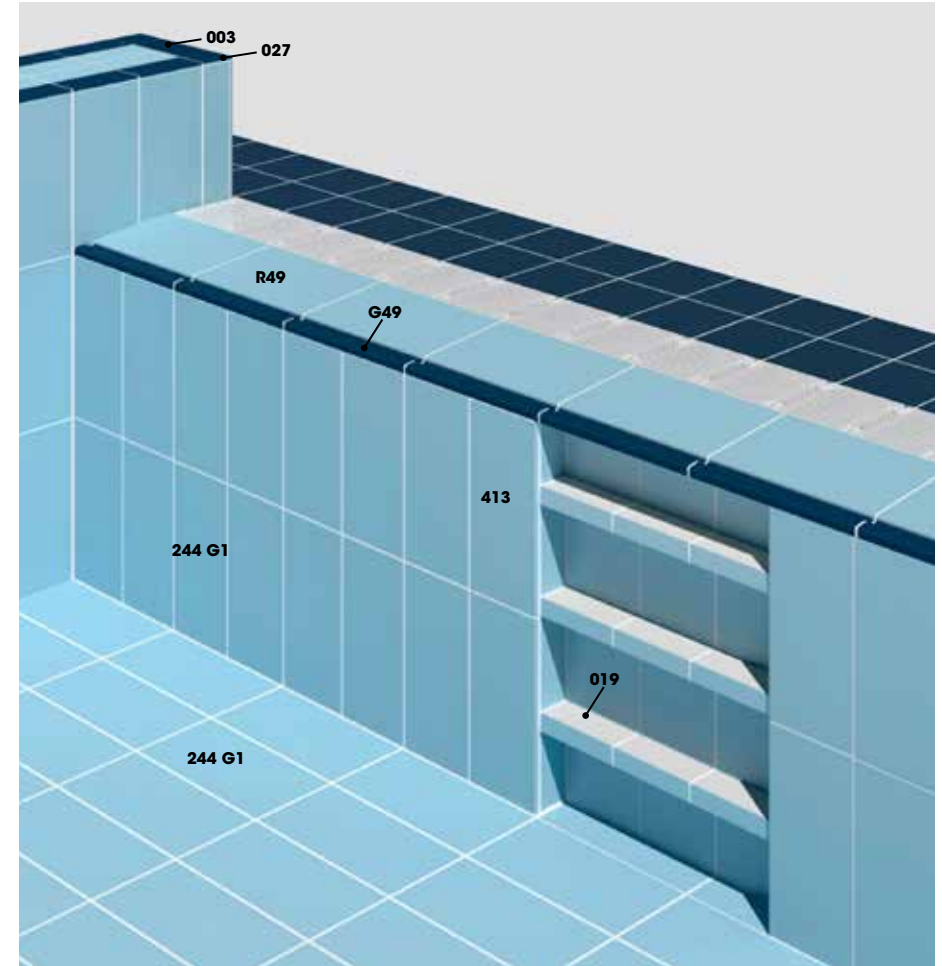

Murete | Headwall for podiums | Muret

### Ergo

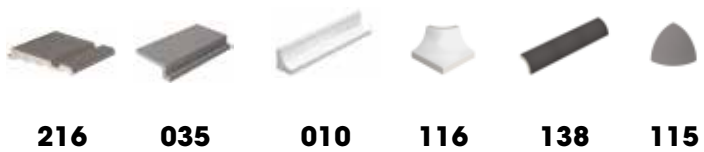
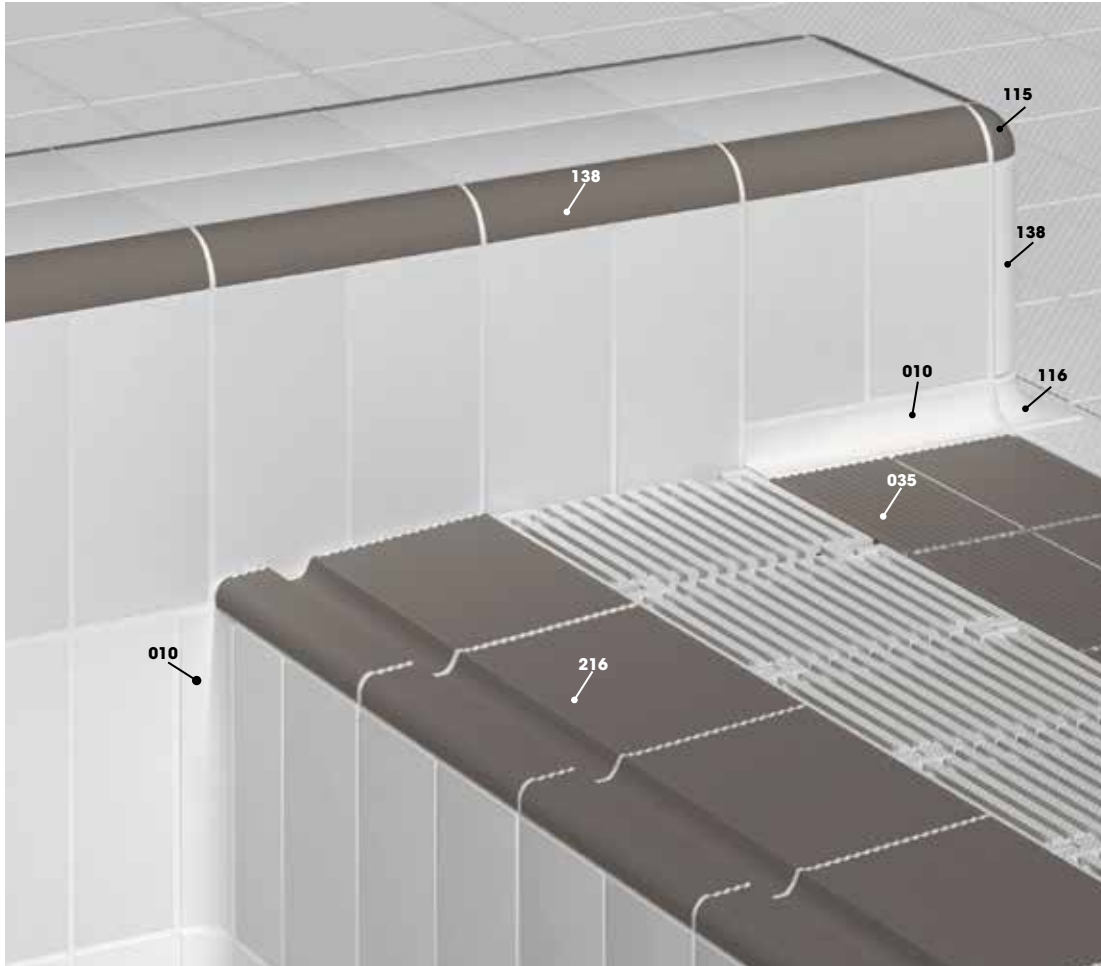

Banco | Bench | Banc

### Wiesbaden

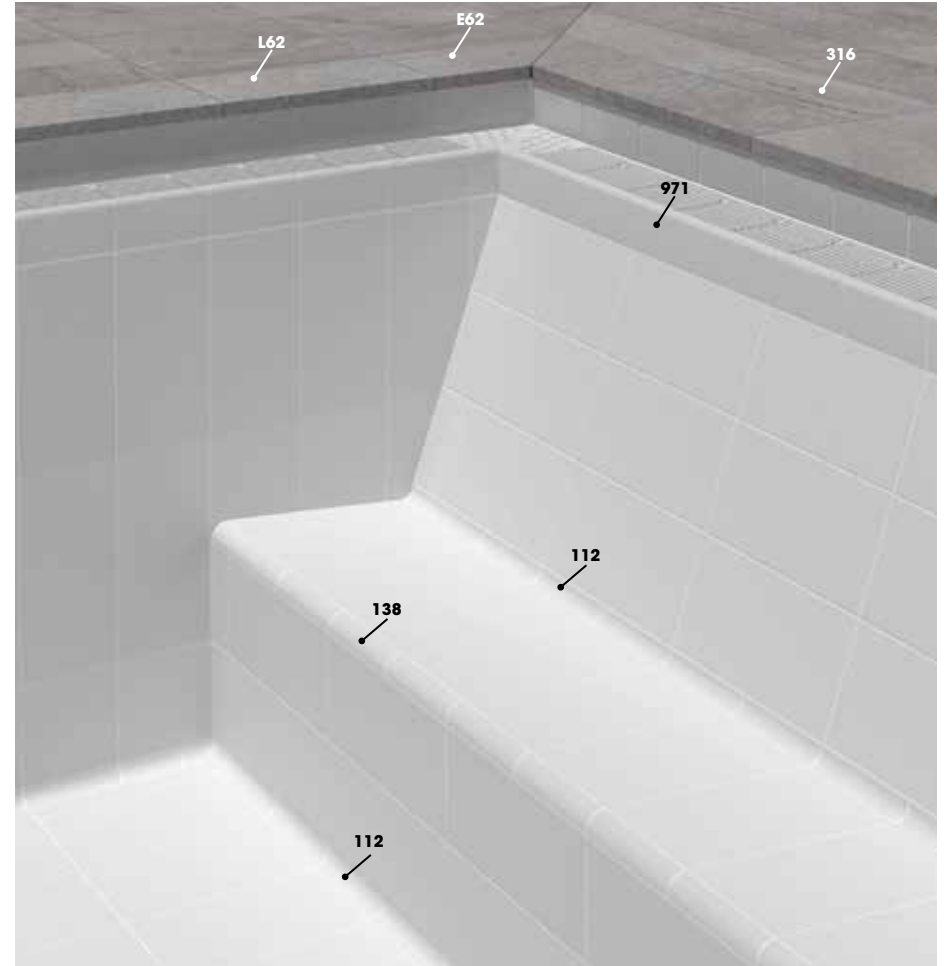



03

EL VASO  
THE TANK  
LE BASSIN

FORMATOS, ACABADOS, COLORES  
FORMATS, FINISHES, COLORS  
FORMATS, FINITIONS, COULEURS

PROGRAMA  
PROGRAM  
PROGRAMME

i'mperfect





### 487

liso / anti-slip  
48,8 x 79,2 x 1  
19" x 31"

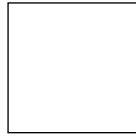

### 490

liso / anti-slip  
48,8 x 48,8 x 1  
19" x 19"



### 316

liso / anti-slip  
31 x 62,6 x 0,9  
12" x 24"



### 240

anti-slip  
24,4 x 24,4 x 1  
9 1/2" x 9 1/2"



### 157

liso / anti-slip  
15,25 x 78,25 x 1  
6" x 31"



### 490 NU

anti-slip  
48,8 x 48,8 x 1  
19" x 19"



### 316 NU

anti-slip  
31 x 62,6 x 0,9  
12" x 24"



### 122

anti-slip  
11,9 x 24,4 x 1  
4 1/2" x 9 1/2"

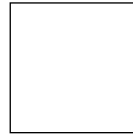

### 490 G6

anti-slip  
48,8 x 48,8 x 1,8  
19" x 19"



### 310

anti-slip  
31 x 31 x 0,9  
12" x 12"



Serena Bianco

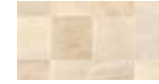

Serena Ocra



Serena Griggio



Serena Nero



Serena Mix



Bohème Vanille



Bohème Brune



Bohème Glacé



Bohème Nuit



Mystery White



Mystery Sand



Mystery Grey



Mystery Blue Stone

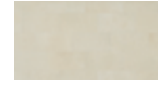

Tao Beige

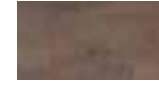

Tao Brown



Tao Silver



Tao Grey



Vintage Bone



Vintage Land



Vintage Brick



Vintage Bronze



Lovely Snow



Lovely Soft



Lovely Dolce



Lovely Smoke



Lovely Vital



Lovely Intense



Lovely Dark



Garden Blanco



Garden Rojo



Garden Moka



Natural 2.0 Palma



Natural 2.0 Hierro



## Medias cañas | Half-round pieces | Demi-cannes

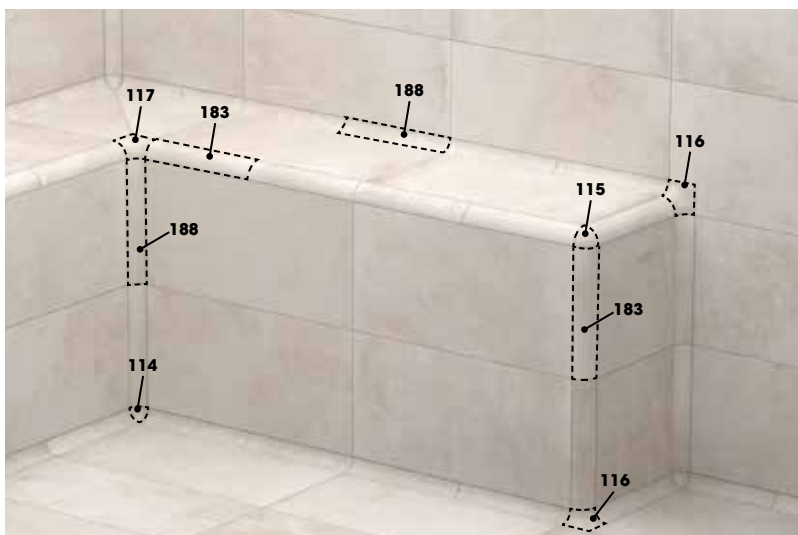

**183** liso <sup>(1)</sup>    **188** liso <sup>(1)</sup>    **114** liso <sup>(1)</sup>    **115** liso <sup>(1)</sup>    **116** liso <sup>(1)</sup>    **117** liso <sup>(1)</sup>    **147** liso <sup>(1)</sup>



(1) Excepto Serena, solo acabado anti-slip  
(1) Except Serena, anti-slip only  
(1) Sauf Serena, seulement disponible en anti-dérapant

## Peldaños | Steps | Marche



**L24** anti-slip    **L31** anti-slip    **L62** anti-slip    **L98** anti-slip    **LM2** anti-slip    **DL1** anti-slip

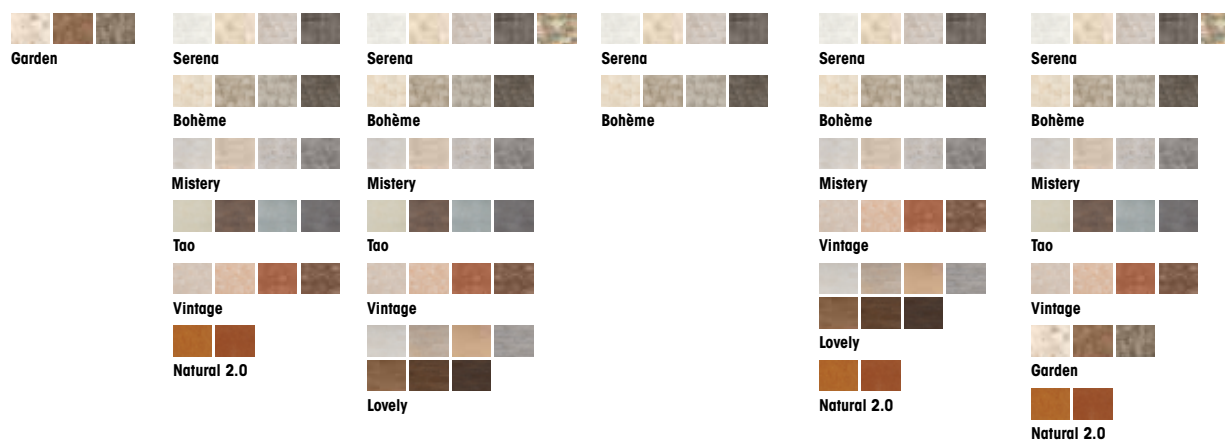

Esquinas | Corners | Angles

Piscina desbordante con asoleadero, escalera y zona Spa | Deck level pool with shallow area, stair and integrated spa | Piscine a débordement avec bain a bulles

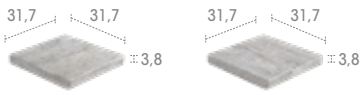

**DLI**  
anti-slip

**DLD**  
anti-slip

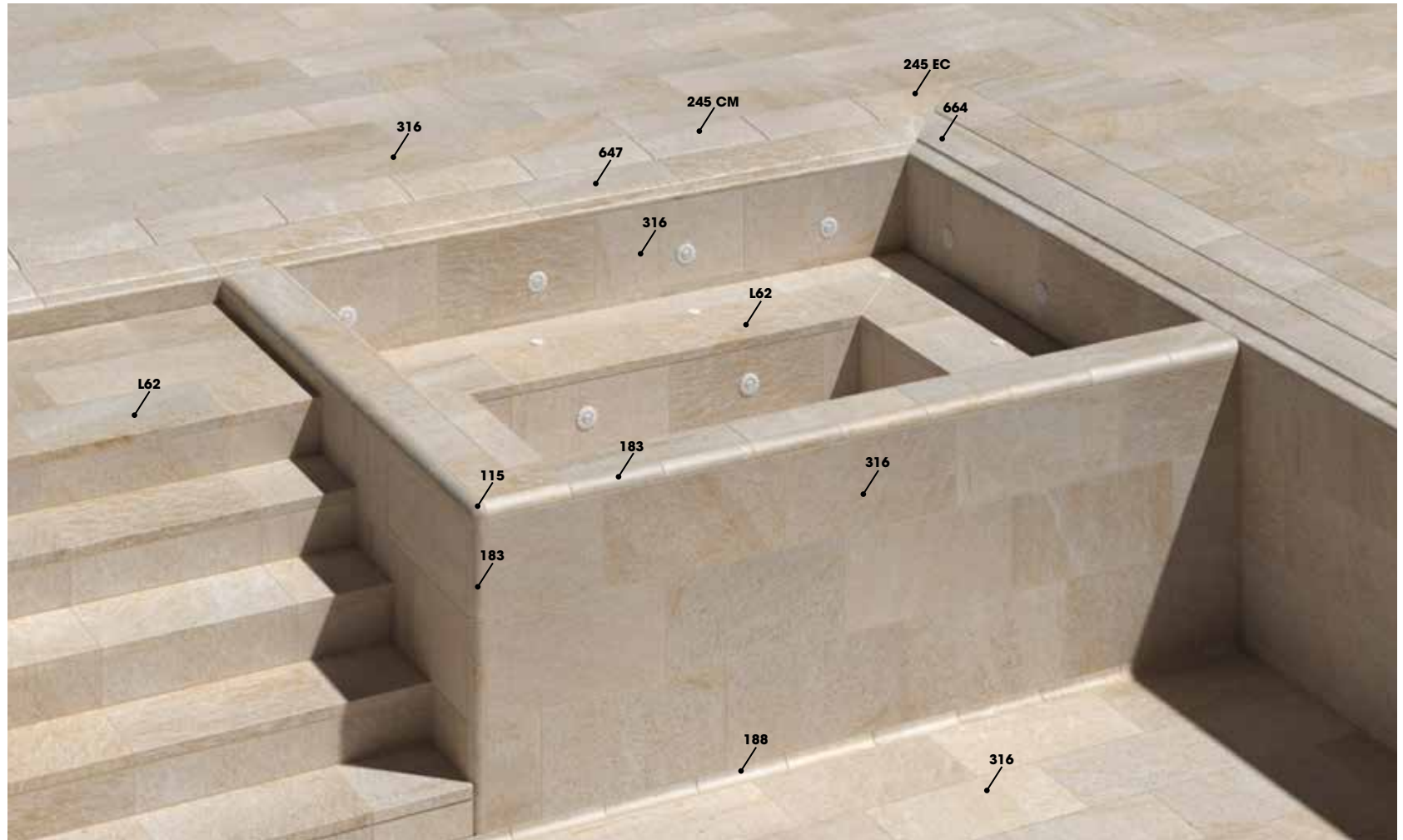







### 244 G1

pastilla  
24,4 x 24,4 x 0,8  
9 1/2" x 9 1/2"

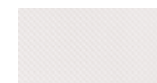

Blanco Pastilla



Marino Pastilla



Caramel Pastilla



Acero Pastilla



Plomo Pastilla



Indubeige Pastilla



Biobeige Pastilla



Putxet Sport, Barcelona, Spain  
Indubeige Pastilla



## Canaletas | Waterways | Cunnetes

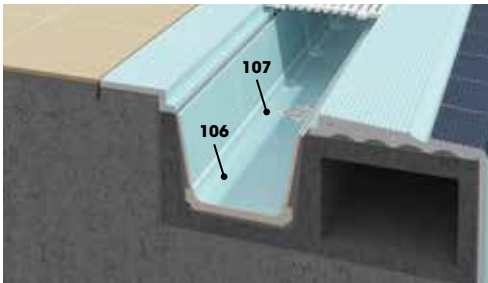

Finn Valley Leisure Center, Donegal, Ireland  
*Blanco*



**204**  
anti-slip

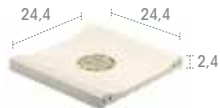

**205**  
anti-slip



**206**  
anti-slip



**207**  
anti-slip

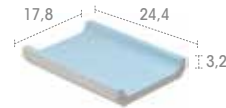

**106**  
liso

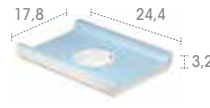

**107**  
liso

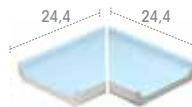

**108**  
liso

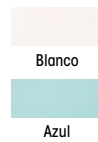

Complejo Deportivo Municipal La Granja, Navia, Vigo, Spain / Naos Arquitectura  
*Acero*





Centre Nautique d'Ottmarsheim, Ottmarsheim, France / Agence Coste Architectures  
*Plomo*



Centre Nautique d'Ottmarsheim, Ottmarsheim, France / Agence Coste Architectures  
*Plomo, Lima, Orange, Blanco*







### 487

liso / anti-slip  
48,8 x 79,2 x 1  
19" x 31"



### 490

liso / anti-slip  
48,8 x 48,8 x 1  
19" x 19"

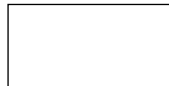

### 316

liso / anti-slip  
31 x 62,6 x 0,9  
12" x 24"



### 240

anti-slip  
24,4 x 24,4 x 1  
9 1/2" x 9 1/2"

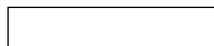

### 157

liso / anti-slip  
15,25 x 78,25 x 1  
6" x 31"



### 490 NU

anti-slip  
48,8 x 48,8 x 1  
19" x 19"



### 316 NU

anti-slip  
31 x 62,6 x 0,9  
12" x 24"



### 122

anti-slip  
11,9 x 24,4 x 1  
4 1/2" x 9 1/2"

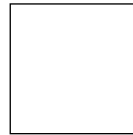

### 490 G6

anti-slip  
48,8 x 48,8 x 1,8  
19" x 19"



### 310

anti-slip  
31 x 31 x 0,9  
12" x 12"



Serena Bianco



Serena Ocra



Serena Griggio



Serena Nero



Serena Mix



Bohème Vanille



Bohème Brune



Bohème Glacé



Bohème Nuit



Mystery White



Mystery Sand



Mystery Grey



Mystery Blue Stone

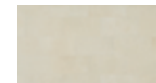

Tao Beige



Tao Brown



Tao Silver



Tao Grey



Vintage Bone



Vintage Land



Vintage Brick



Vintage Bronze



Lovely Snow



Lovely Soft



Lovely Dolce



Lovely Smoke



Lovely Vital



Lovely Intense



Lovely Dark



Garden Blanco



Garden Rojo



Garden Moka



Natural 2.0 Palma



Natural 2.0 Hierro





Centre Aquatique d'Arcachon, France / Atelier Arcos Architecture  
Blanco / Mistery Grey

### Canaletas | Waterways | Cunnetes

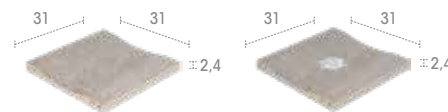
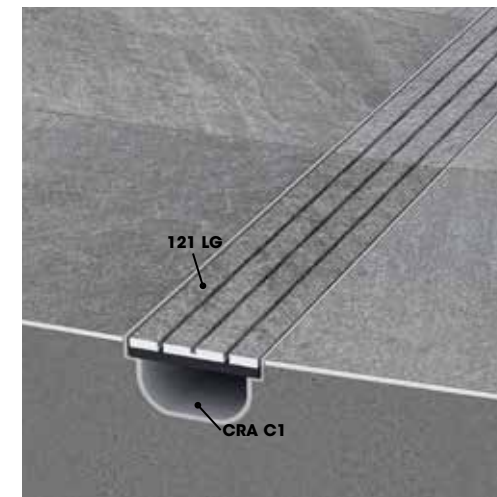

**367**  
anti-slip

**368**  
anti-slip

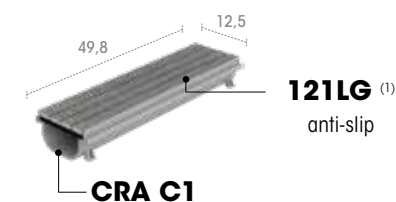

**121LG** (1)  
anti-slip

**CRA C1**



Serena



Bohème



Mistery



Tao



Vintage



Lovely



Natural 2.0



Serena



Bohème



Mistery

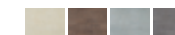

Tao



Vintage



Lovely



Garden

Natural 2.0

(1) Garden 12,5 x 24,4 x 2,2 / Natural 2.0 12,5 x 31 x 2,2



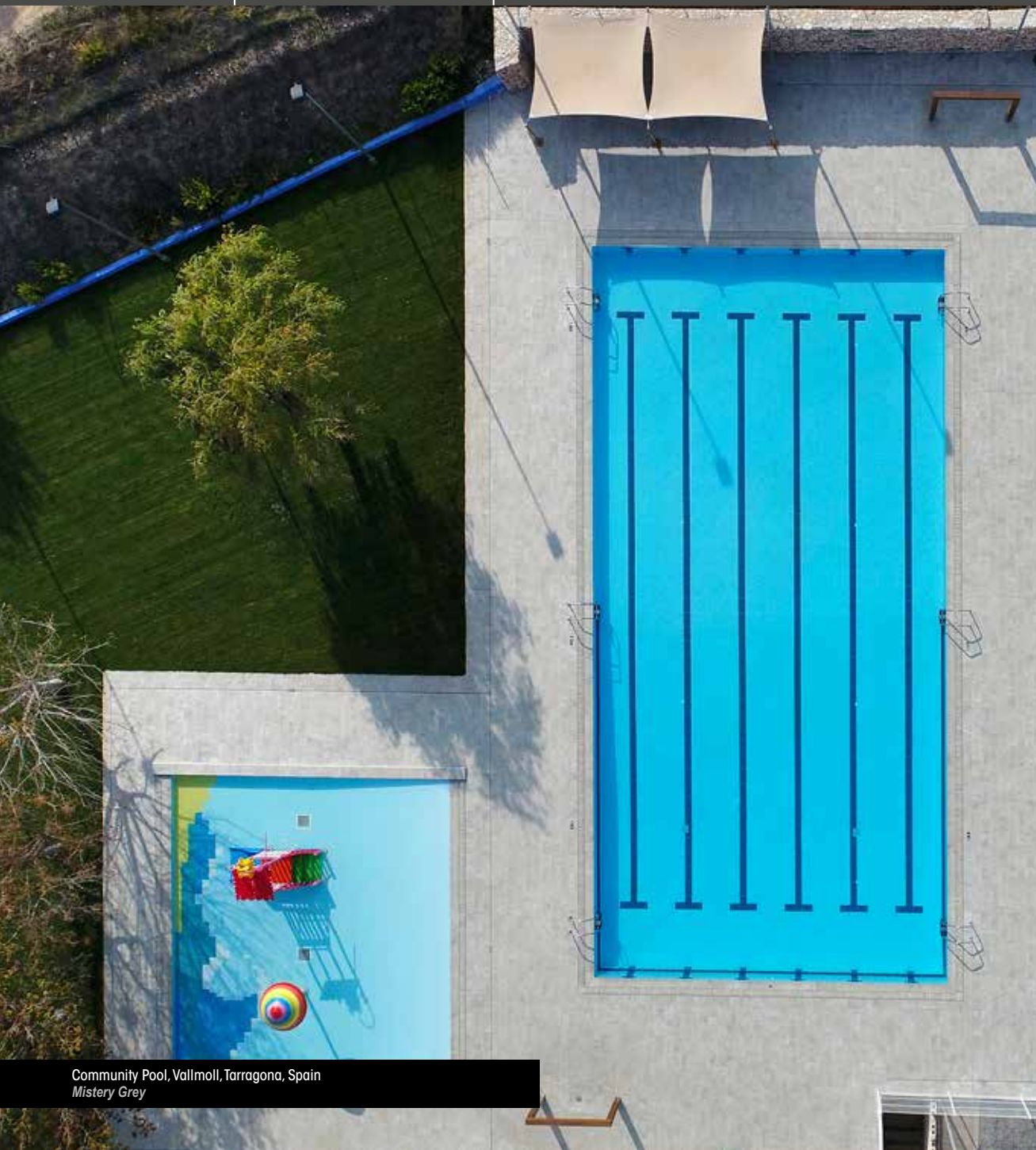

Community Pool, Vallmoll, Tarragona, Spain  
Mystery Grey



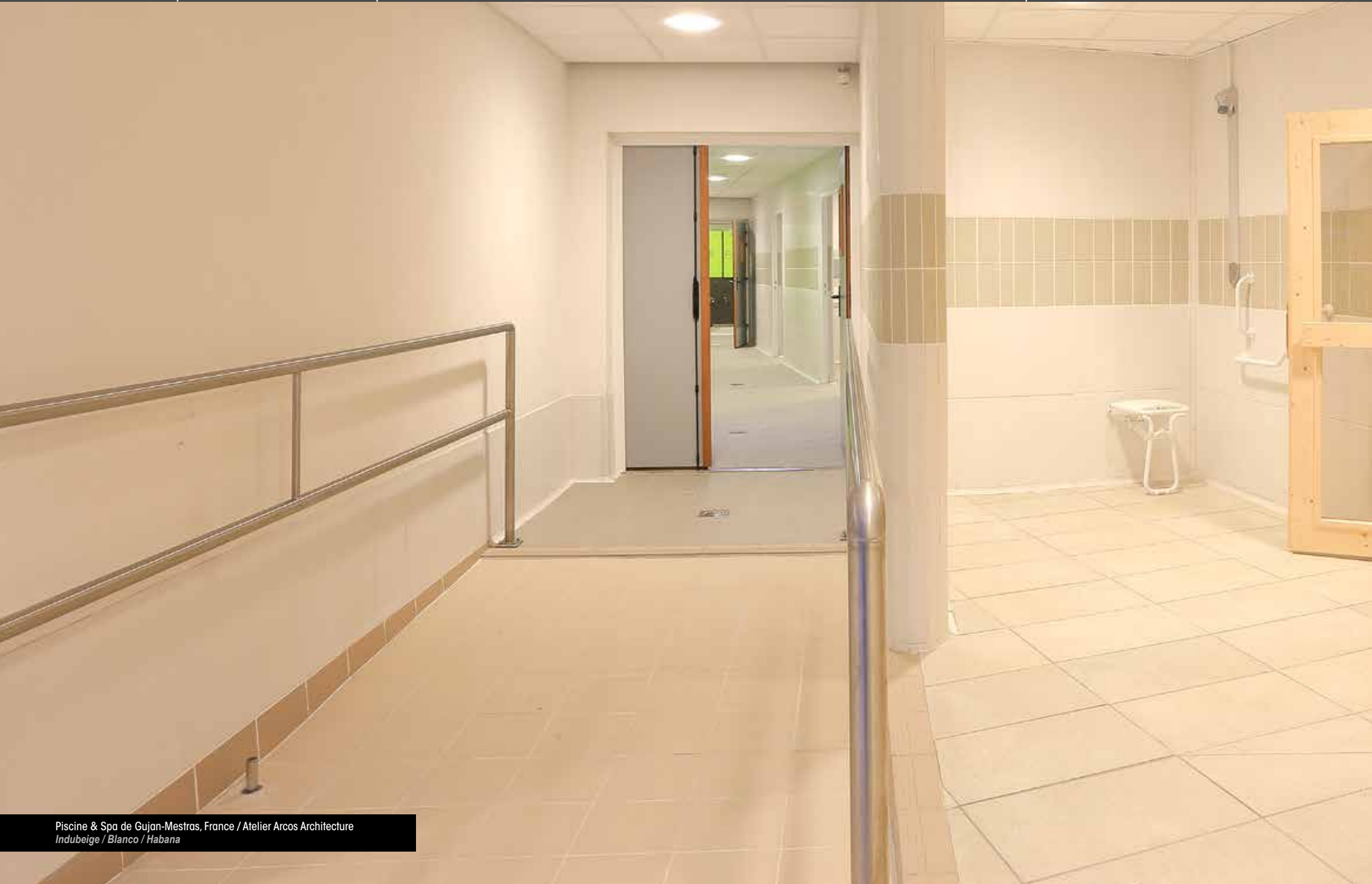



**244 G1**  
liso / anti-slip  
24,4 x 49,4 x 0,8  
9 1/2" x 19 1/2"



**240 G1**  
pastilla  
24,4 x 24,4 x 0,8  
9 1/2" x 9 1/2"



**122 G1**  
liso / anti-slip  
11,9 x 24,4 x 0,8  
4 1/2" x 9 1/2"



**122 G5**  
R10 - R11 - R12  
11,9 x 24,4 x 1,4  
4 1/2" x 9 1/2"



**052 G1**  
liso  
5,6 x 24,4 x 0,8  
2" x 9 1/2"



**240 G3**  
R9 - R10 - R11 - R12  
24,4 x 24,4 x 1  
9 1/2" x 9 1/2"



**122 G3**  
R9 - R10 - R11 - R12  
11,9 x 24,4 x 1  
4 1/2" x 9 1/2"



**122 G6**  
R10 - R11  
11,9 x 24,4 x 1,8  
4 1/2" x 9 1/2"

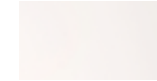

Blanco



Azul



Marino



Caramel



Acero



Plomo



Ultramar



Prusia



Esmeralda



Habana



Lima



Oliva



Violet



Amarillo



Orange



Rojo N

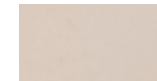

Indubeige



Indu Tech



Indu Grey



Bio - White

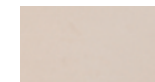

Biobeige



Biobeige Pastilla



## Medias cañas | Half-round pieces | Demi-cannes

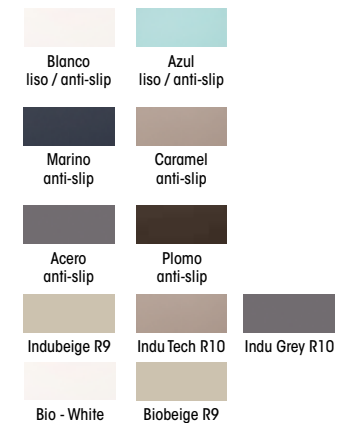
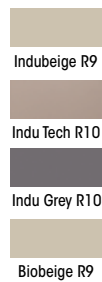
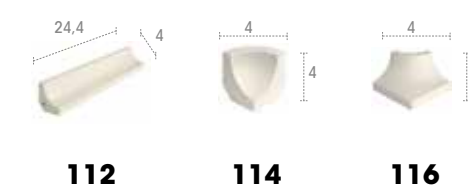
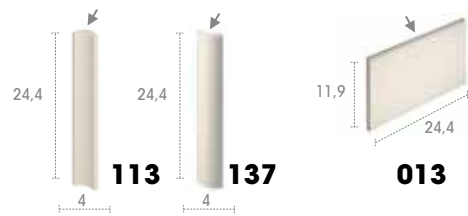
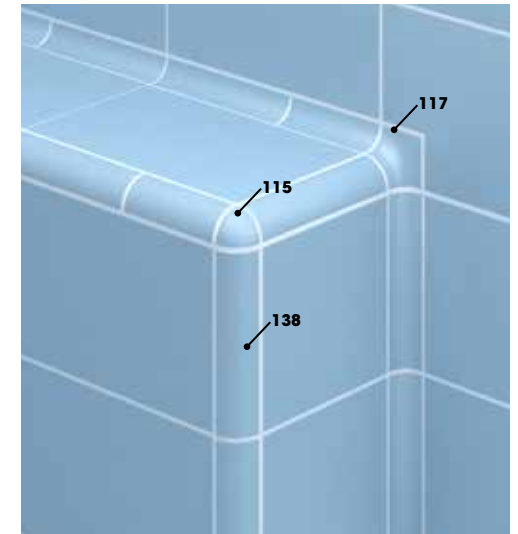
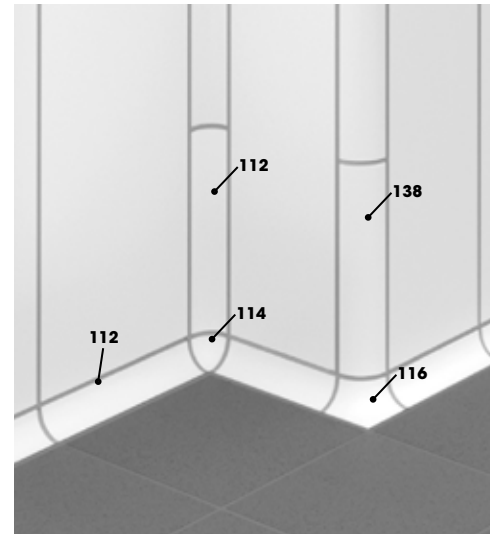
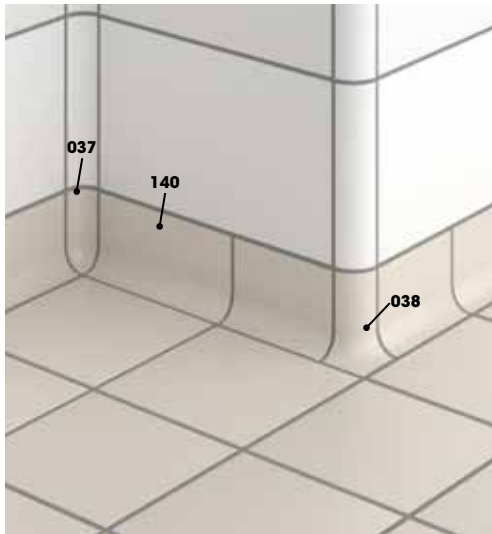



### Canaletas | Waterways | Cunnetes

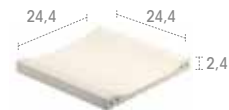
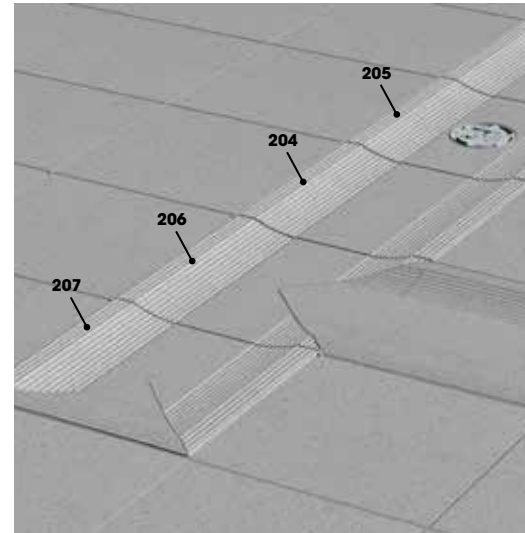

**204**

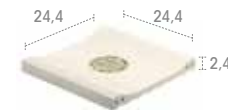

**205**



**130**

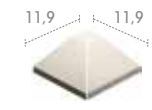

**136**

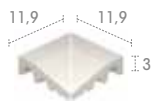

**131**



**206**



**207**

- |                   |                     |               |              |
|-------------------|---------------------|---------------|--------------|
|                   |                     |               |              |
| Blanco anti-slip  | Marino anti-slip    | Indubeige R10 | Biobeige R10 |
|                   |                     |               |              |
| Caramel anti-slip | Acero anti-slip     | Indu Tech R10 |              |
|                   |                     |               |              |
| Plomo anti-slip   | Indubeige anti-slip | Indu Grey R10 |              |

- |               |              |
|---------------|--------------|
|               |              |
| Indubeige R10 | Biobeige R10 |
|               |              |
| Indu Tech R10 |              |
|               |              |
| Indu Grey R10 |              |







### 487

liso / anti-slip  
48,8 x 79,2 x 1  
19" x 31"

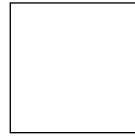

### 490

liso / anti-slip  
48,8 x 48,8 x 1  
19" x 19"



### 316

liso / anti-slip  
31 x 62,6 x 0,9  
12" x 24"



### 240

anti-slip  
24,4 x 24,4 x 1  
9 1/2" x 9 1/2"



### 157

liso / anti-slip  
15,25 x 78,25 x 1  
6" x 31"

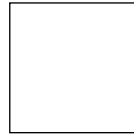

### 490 G6

anti-slip  
48,8 x 48,8 x 1,8  
19" x 19"



### 310

anti-slip  
31 x 31 x 0,9  
12" x 12"



### 122

anti-slip  
11,9 x 24,4 x 1  
4 1/2" x 9 1/2"



Serena Bianco



Serena Ocra



Serena Griggio



Serena Nero



Serena Mix



Bohème Vanille



Bohème Brune



Bohème Glacé



Bohème Nuit



Mystery White



Mystery Sand



Mystery Grey



Mystery Blue Stone

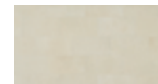

Tao Beige



Tao Brown



Tao Silver



Tao Grey



Vintage Bone



Vintage Land



Vintage Brick



Vintage Bronze



Lovely Snow



Lovely Soft



Lovely Dolce



Lovely Smoke



Lovely Vital



Lovely Intense



Lovely Dark



Garden Blanco



Garden Rojo



Garden Moka



Natural 2.0 Palma



Natural 2.0 Hierro



## Medias cañas | Half-round pieces | Demi-cannes

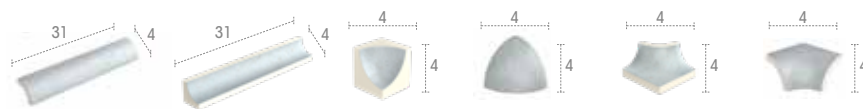

**183**  
liso (1)

**188**  
liso (1)

**114**  
liso (1)

**115**  
liso (1)

**116**  
liso (1)

**117**  
liso (1)

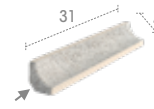

**147**  
liso (1)



(1) Excepto Serena, solo acabado anti-slip  
(1) Except Serena, anti-slip only  
(1) Sauf Serena, seulement disponible en anti-dérapant

Romo / Bullnose / Arrondie

## Canaletas | Waterways | Cunnetes



**367**  
anti-slip

**368**  
anti-slip

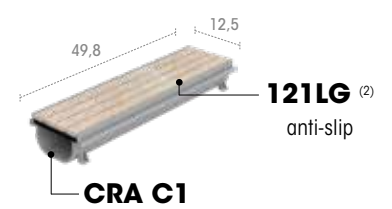

**121LG (2)**  
anti-slip

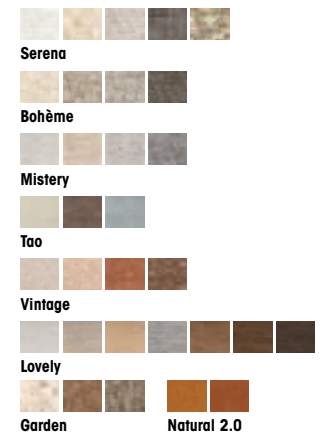

(2) Garden 12,5 x 24,4 x 2,2 / Natural 2.0 12,5 x 31 x 2,2



Centre Aquatique Chatillon-sur-Chalaronne, France / Agence Coste Architectures  
Vintage Bone



Centre Aquatique d'Arcachon, France / Atelier Arcos Architecture  
Mystery Grey



Camping Clarà, Torredembarra, Spain  
Bohème Glacé







**487**

liso / anti-slip  
48,8 x 79,2 x 1  
19" x 31"

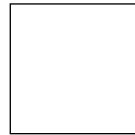

**490**

liso / anti-slip  
48,8 x 48,8 x 1  
19" x 19"

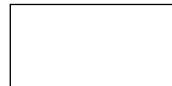

**316**

liso / anti-slip  
31 x 62,6 x 0,9  
12" x 24"



**240**

anti-slip  
24,4 x 24,4 x 1  
9 1/2" x 9 1/2"



**157**

liso / anti-slip  
15,25 x 78,25 x 1  
6" x 31"

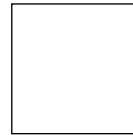

**490 G6**

anti-slip  
48,8 x 48,8 x 1,8  
19" x 19"



**310**

anti-slip  
31 x 31 x 0,9  
12" x 12"



**122**

anti-slip  
11,9 x 24,4 x 1  
4 1/2" x 9 1/2"



Serena Bianco



Serena Ocra



Serena Griggio



Serena Nero



Serena Mix



Bohème Vanille



Bohème Brune



Bohème Glacé



Bohème Nuit



Mistery White



Mistery Sand



Mistery Grey



Mistery Blue Stone

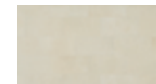

Tao Beige



Tao Brown



Tao Silver



Tao Grey



Vintage Bone



Vintage Land



Vintage Brick



Vintage Bronze

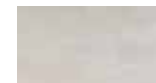

Lovely Snow



Lovely Soft



Lovely Dolce



Lovely Smoke



Lovely Vital



Lovely Intense



Lovely Dark



Garden Blanco



Garden Rojo



Garden Moka



Natural 2.0 Palma



Natural 2.0 Hierro



Peldaños, zócalos y esquinas | Steps, bullnoses and corners | Marches, plinthes et angles

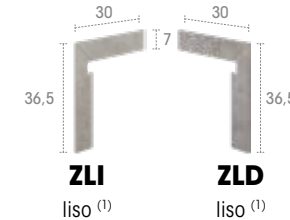
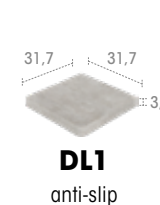
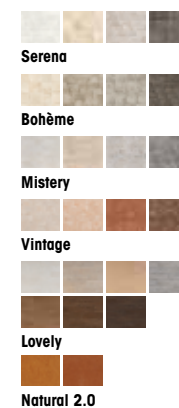
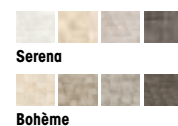
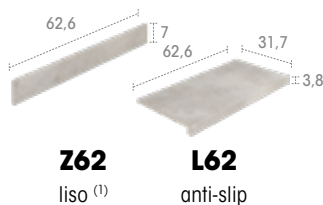
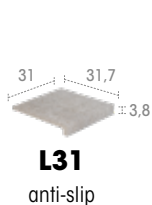
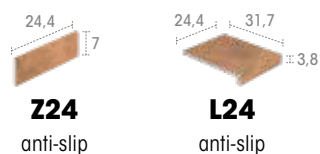
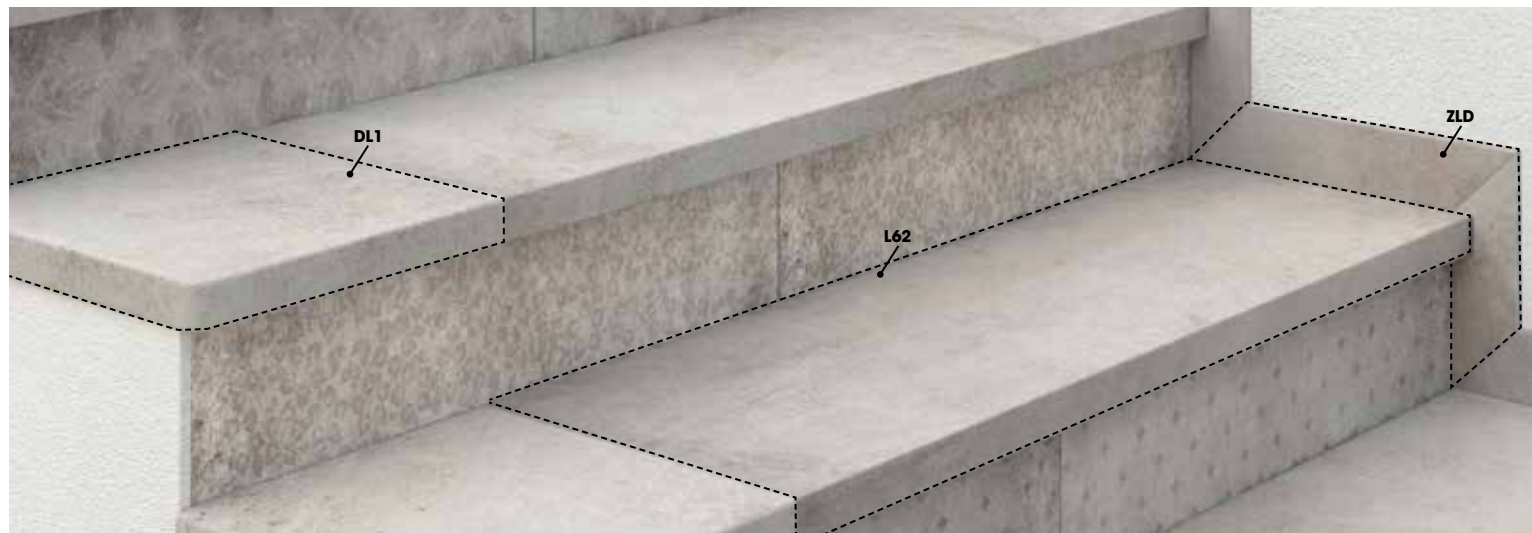
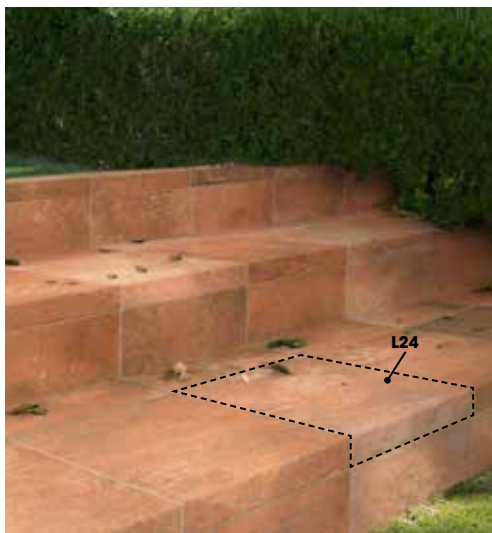

(1) Excepto Serena, solo acabado anti-slip  
(1) Except Serena, anti-slip only  
(1) Sauf Serena, seulement disponible en anti-dérapant

**Peldaños, zócalos y esquinas | Steps, bullnoses and corners | Marches, plinthes et angles**

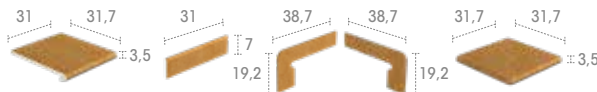

**DLI**  
anti-slip

**DLD**  
anti-slip

**P31**  
anti-slip

**Z31**  
anti-slip

**ZPI**  
anti-slip

**ZPD**  
anti-slip

**DP1**  
anti-slip



Lovely



Natural 2.0

**Canaletas | Waterways | Cunnetes**

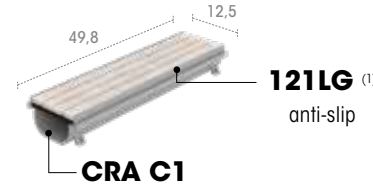
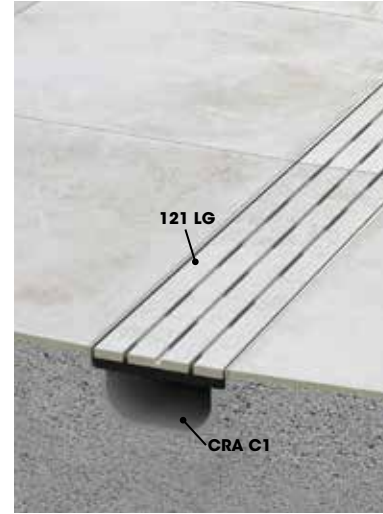

Serena



Bohème



Mistery



Tao

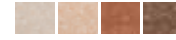

Vintage



Lovely



Garden



Natural 2.0

(1) Garden 12,5 x 24,4 x 2,2 / Natural 2.0 12,5 x 31 x 2,2



Private House / Josep Aurell, GAAB Arquitectes  
Mistery White





Casas del Lago Hotel, Spa & Beach Club, Ciutadella, Spain / Roberto Duarte Architect  
Serena Nero



Horizont Resort, Stará Lesná, Slovakia / Archstudio  
Tao Grey





Gran Hotel Miramar, Málaga, Spain / Roberto Duarte Architect  
*Serena Bianco*



Hotel Casa Vilella, Sitges, Spain / Alfonso Morales Comella Architect  
*Vintage Land*







Hotel Cap Negret, Altea, Spain  
Mystery Grey



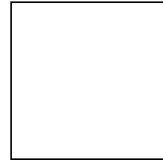

**600**

liso / abujardado  
59,8 x 59,8 x 1  
24" x 24"

**306**

liso / abujardado  
29,8 x 59,8 x 1  
12" x 24"

**300**

abujardado  
29,8 x 29,8 x 1  
12" x 12"



Projecta Petra



Projecta Arena



Projecta Perla



Projecta Selenio



Projecta Onix



Hotel Lani's Suites de Luxe, Lanzarote, Spain  
Projecta Petra



**Peldaños, zócalos y esquinas | Steps, bullnoses and corners | Marches, plinthes et angles**



Hotel Lani's Suites de Luxe, Lanzarote, Spain  
Proycta Petra

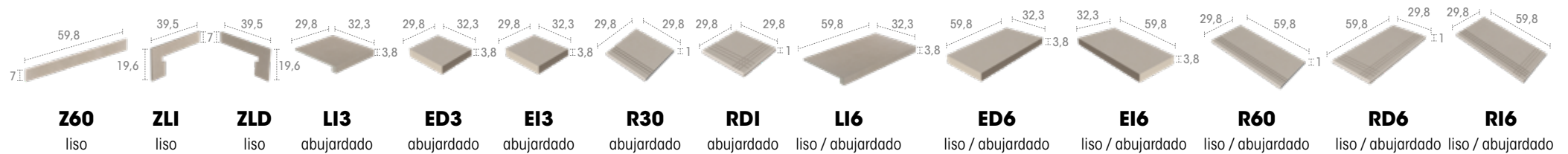

## Medias cañas y canaletas | Half-round pieces and waterways | Demi-cannes et cunettes



Hostal Empúries, L'Escala, Girona, Spain  
Proycta Onix

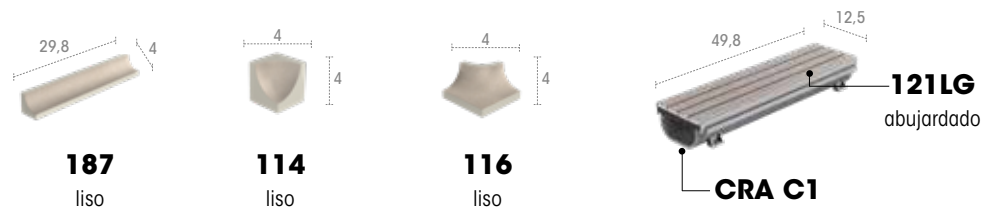



## REJILLAS / GRATING / GRILLE

**REJILLA  
GRATING  
GRILLE**

**245 R2** 24,5 x 19,5 x 2,2  
**295 R2** 29,5 x 19,5 x 2,2  
**335 R2** 33,5 x 19,5 x 2,2

**PLACA ESQUINA 90°  
90° CORNER PLASTIC PIECE  
ANGLE POUR CAILLEBOTIS 90°**

**195 E2** 19,5 x 19,5 x 2,2  
**245 E2** 24,5 x 24,5 x 2,2  
**295 E2** 29,5 x 29,5 x 2,2  
**335 E2** 33,5 x 33,5 x 2,2  
**195 E3** 20 x 20 x 3,5  
**245 E3** 25 x 25 x 3,5  
**295 E3** 30 x 30 x 3,5  
**335 E3** 34 x 34 x 3,5

**REJILLA LONGITUDINAL  
LONGITUDINAL GRATE  
GRILLE PARALLÈLE**

**195 L2** 19,5 x 20,6 x 2,4  
**245 L2** 24,5 x 20,6 x 2,4  
**295 L2** 29,5 x 20,6 x 2,4  
**345 L2** 34,5 x 20,6 x 2,4

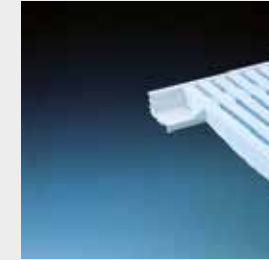
**PERFIL SOPORTE MIL (1)  
GRATING SUPPORT PROFILE (1)  
PROFIL SUPORT GRILLE (1)**

**243 PF** 2,4 x 3,7 x 200

**CURVAS Y RECTAS  
MODULAR GRATE FOR BENDS  
GRILLE POUR COURBES**

**195 V2** 19,5 x 2,2  
**245 V2** 24,5 x 2,2  
**295 V2** 29,5 x 2,2  
**335 V2** 33,5 x 2,2  
**195 V3** 19,5 x 3,5  
**245 V3** 24,5 x 3,5  
**295 V3** 29,5 x 3,5  
**335 V3** 33,5 x 3,5

**TERMINAL  
LONGITUDINAL  
END PIECE FOR LONGITUDINAL  
GRATING  
BORNE POUR  
GRILLE LONGITUDINALE**

**195 TO** 19,5 x 2,4  
**245 TO** 24,5 x 2,4  
**295 TO** 29,5 x 2,4  
**345 TO** 34,5 x 2,4

**REJILLA LONGITUDINAL  
LONGITUDINAL GRATE  
GRILLE PARALLÈLE**

**245 L2** 24,5 x 100 x 2,4

**CURVAS Y RECTAS  
MODULAR GRATE FOR BENDS  
GRILLE POUR COURBES**

**245 V2** 2,5 x 250 x 2,4

**REJILLA (2)  
GRATING (2)  
GRILLE (2)**

**245 R2** 24,5 x 250 x 2,4

**PLACA ESQUINA 90°  
90° CORNER PLASTIC PIECE  
ANGLE POUR CAILLEBOTIS 90°**

**245 E2** 24,5 x 24,5 x 2,4

**REJILLA MADERA  
WOOD GRATING  
GRILLE EN BOIS**

**PARA INTERIOR  
ONLY INDOOR  
POUR L'INTÉRIEUR**

**986** 24,5 x 50 x 2,2

**REJILLA MADERA  
WOOD GRATING  
GRILLE EN BOIS**

**TERMINAL  
ENDING PIECE  
PIÈCE DE FINITION**

**988**

## CORCHERAS / CORK FLOATS LINE / LIGNE SEPARATION COULOIRS

**CORCHERA MODELO (3)  
CORK FLOATS LINE (3)  
LIGNE SEPARATION (3)**

**ROMM2**  
25

**ROMM5**  
50

**ANCLAJE INCLINADO  
SLOPING ANCHORAGE  
ANCRAGE INCLINÉ**

**ANIH1**  
Ø43 Tubo / Tube / Tubez

**ANIH2**  
Ø48 Tubo / Tube / Tubez

**ANCLAJE PLANO  
FLAT ANCHORAGE  
ANCRAGE PLAT**

**ANPH1**  
Ø43 Tubo / Tube / Tubez

**ANPH2**  
Ø48 Tubo / Tube / Tubez

**SOPORTE CORCHERA  
CORK FLOATS HOLDER  
SUPPORT LIGNE  
SÉPARATION COULOIRS**

**SPCH1**  
Ø43 Anclaje / Anchorage  
Ancrage

**COPA ANCLAJE  
ANCHOR CUP  
COUPE D'ANCRE**

**CAE00**

Anclaje escamotable  
Retractable anchor  
Ancre rétractable

**ANCLAJE TORNILLO  
SCREW ANCHOR  
ANCRAGE VIS**

**ANTH1**  
Ø43 Tubo / Tube  
Tubez

(1) Se necesitan 2 unidades para sujetar la rejilla. Se venden por piezas de 2 m / 2 units required to hold the grid. Sold in units of 2 m / Il faut 2 unités pour supporter la grille. Vente par pièces de 2 m

(2) Se venden por piezas de 2'5 m / Sold in units of 2'5 m / Vente par pièces de 2'5 m

(3) Anclajes no incluidos / Anchorages not included / Ancrages pas compris

(4) Escaleras con peldaños personalizables de gres porcelánico / Stairs with customized porcelain stoneware steps / Escalier avec des marches en grès cérame personnalisables

(5) Numeración no incluida / Podium numbers not included / Numéros des podiums pas considérés

## ESCALERAS / STAIRS / ÉCHELLES



**MODELO 1000** (4)  
**MODEL 1000** (4)  
**MODÈLE 1000** (4)  
**MIGX3** (3)  
3 Peldaños / Steps / Marches  
**MIGX4**  
4 Peldaños / Steps / Marches



**ESCALERA PARTIDA** (4)  
**SPLIT STAIRS** (4)  
**ÉCHELLE SÉPARÉE** (4)  
**PIGX3**  
3 Peldaños / Steps / Marches  
**PIGX4**  
4 Peldaños / Steps / Marches



**ESCALERA PARTIDA ERGO** (4)  
**ERGO SPLIT STAIR** (4)  
**ÉCHELLE SÉPARÉE ERGO** (4)  
**EIGZ3**  
3 Peldaños / Steps / Marches  
**EIGZ4**  
4 Peldaños / Steps / Marches



**ESCALERA CON PASAMANOS**  
**MODELO 1000**  
**STAIR WITH HANDRAIL**  
**MODEL 1000**  
**ÉCHELLE AVEC RAMPE**  
**MODEL 1000**  
**MILX3**  
3 Peldaños / Steps / Marches  
**MILX4**  
4 Peldaños / Steps / Marches



**ESCALERA MODELO PARTIDA**  
**MODEL SPLIT STAIRS**  
**ÉCHELLE AVEC RAMPE SÉPARÉE**  
**PTDX3**  
3 Peldaños / Steps / Marches  
**PTDX4**  
4 Peldaños / Steps / Marches



**ESCALERA PARTIDA MODELO ERGO**  
**STAIR WITH HANDRAIL ERGO MODEL**  
**ÉCHELLE SÉPARÉE MODEL ERGO**  
**EPEZ3**  
3 Peldaños / Steps / Marches  
**EPEZ4**  
4 Peldaños / Steps / Marches



**ESCALERA ASIMÉTRICO**  
**ASYMMETRIC STAIR**  
**ÉCHELLE ASYMÉTRIQUE**  
**SMA00**  
2 Pasamanos / Handrail  
Rampes1000



**SALIDAS ANCLAJE**  
**INTERIOR / EXTERIOR**  
**EXTERNAL / INTERNAL**  
**HOLDER EXITS**  
**SORTIES EXTÉRIEUR / INTÉRIEUR**  
**POUR ENCASTRER**  
**PAS00**  
043 Acero Inox / Steel Inox / Acier Inox

## SEÑALIZACIÓN / SIGNS / ÉCHELLES



**SEÑALIZACIÓN SALIDA FALSA PARA POSTES** (3)  
**FALSE START SIGNALING FOR POLES** (3)  
**SIGNALIZATION FAUSSE SORTIE** (3)  
**SS FH 1**  
Ø43 Postes / Poles / Poteaux  
**SS FH 2**  
Ø48 Postes / Poles / Poteaux  
**SS FFC**  
Cuerda poliéster / Polyester rope / Corde polyester



**PODIUM SALIDA**  
**NADADORES** (5)  
**SWIMMERS' START**  
**PODIUM** (5)  
**PODIUM NAGEURS** (5)  
**PDAH7**  
70 cm altura - azul  
70 cm high - blue  
70 cm hauteur - bleu



**BANDERINES** (3)  
**SIGNAL FLAGS** (3)  
**POTEAUX FANIONS** (3)  
**BDNH1**  
Ø43 Postes / Poles / Poteaux  
**BDNH2**  
Ø48 Postes / Poles / Poteaux  
**BDNHBC**  
2 Cuerdas y bandera / Strings and signal  
flags / Cordes et fanion



**SALVAVIDAS**  
**LIFE PRESERVER**  
**BOUÉE DE SAUVETAGE**  
**SAL PL**  
Plástico / Plastic / Plastique  
**SAL LN**  
Lona / Canvas / Toile



**ELEVADOR HIDRÁULICO**  
**HYDRAULIC ELEVATOR**  
**ÉLÉVATEUR HYDRAULIQUE**  
**ELVML**  
Pasamanos / Handrail / Rampes1000  
**ELV65**  
Pasamanos / Handrail / Rampes 650

## SEÑALIZACIÓN / SIGNS / ÉCHELLES



**SOPORTE SALVAVIDAS**  
**LIFE PRESERVER SUPPORT**  
**SUPPORT PIED BOUÉE**  
**SSV00**



**PIE SOPORTE SALVAVIDAS**  
**LIFE PRESERVER STAND**  
**SUPPORT PIED BOUÉE**  
**DE SAUVETAGE**  
**PSV00**



**ANCLAJE POLIPROPILENO**  
**POLYPROPYLENE ANCHORAGE**  
**ANCRAGE EN POLYPROPYLÈNE**  
**ANEH 1**



**DESAGÜE PVC**  
**PVC DRAINS**  
**DRAIN PVC**  
**990**



**SILENCIADOR DE DESAGÜE**  
**DRAIN SILENCER**  
**SILENCIEUX**  
**DS2**



**PP HOMOPOLÍMERO**  
**PP HOMOPOLYMER**  
**RONDELLE DE**  
**HOMOPOLYMERE**  
**EMB 00**

## OTRAS OPCIONES / OTHER OPTIONS / AUTRES OPTIONS

NOTA: Los complementos de acero inoxidable no son aptos para piscinas de agua marina / NOTE: Stainless steel complements aren't suitable for sea-water pools / REMARQUE: Les compléments en acier inoxydable ne sont pas adaptés aux piscines d'eau de mer



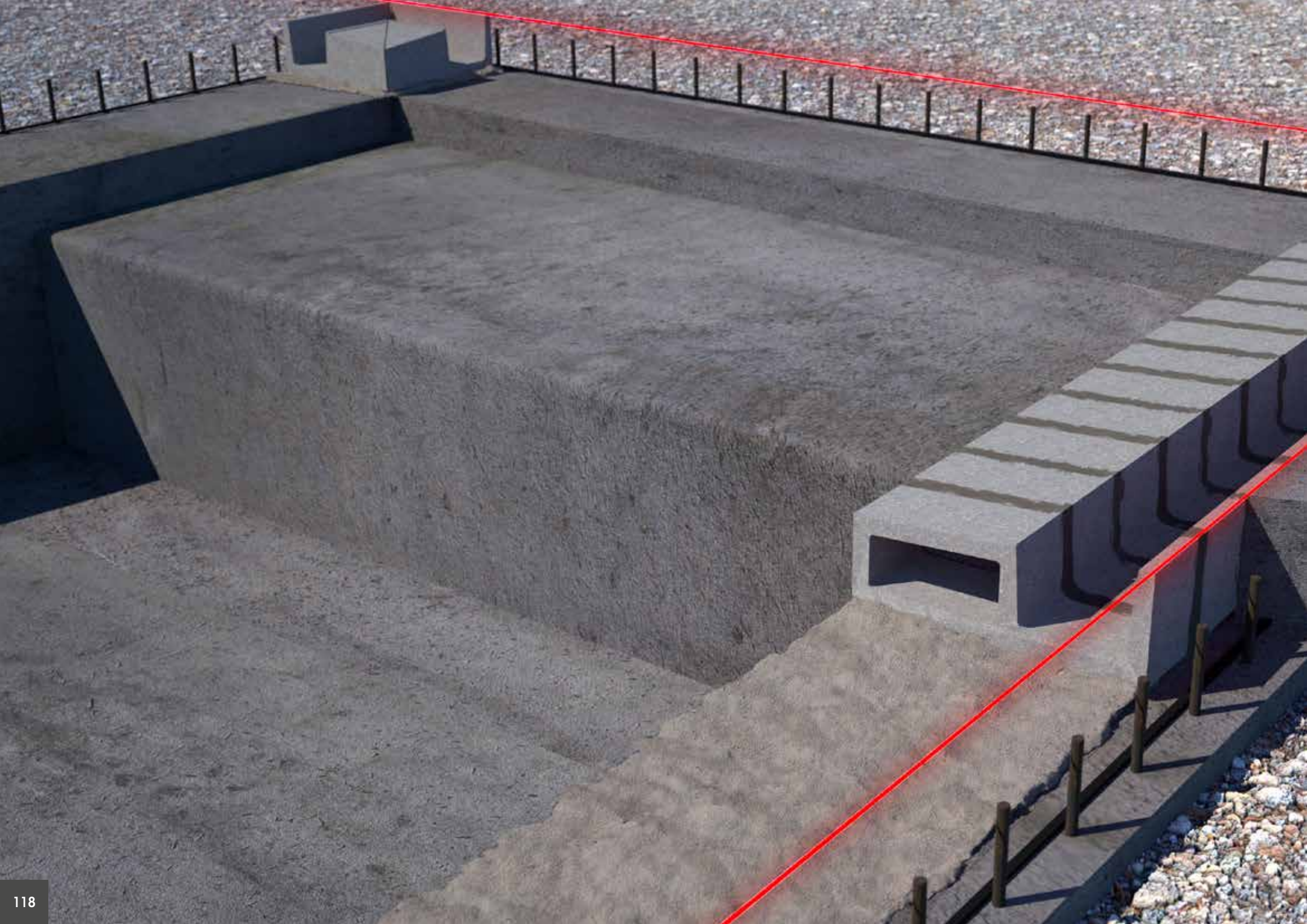





Información | **Técnica**

**Technical** | Información

Information | **Technique**



**Estanqueidad**  
Watertight structure  
Étanchéité

**FUGA-STOP**

Cordón hidro-expansivo para el sellado seguro del hormigonado en piscinas.  
Hydro-expanding strip for watertight sealing of swimming pool joints.  
Cordon hydro-expansif pour le scellement étanche de joints de construction.



Se coloca FUGA-STOP en la unión solera-pared.  
Place FUGA-STOP in the center of the working joint you want to seal.  
Empêcher les futures fuites dans l'union mur-sol grâce à FUGA-STOP.



Se sujeta con clavos o con masilla MASTIC MS.  
Fix it with simple nails or with MASTIC MS.  
A fixer à l'aide de clous ou MASTIC MS.

**Sellado de la unión PVC hormigón**  
How to avoid leaks in the PVC-concrete union  
Comment empêcher les fuites dans les traversées de paroi en PVC

**SELLADOR S10**

Sellador que se presenta en forma de masilla fácilmente aplicable con pistola, previa imprimación.  
Polyurethane filler with extraordinary elasticity to apply on concrete after first applying a primer.  
Mastic en polyuréthane pour béton avec primer préalable d'accroche.



Imprimación previa del hormigón y del tubo de PVC. Aplicar PRIMER SELLADOR S10.  
Seal all the plastic-concrete joints: apply PRIMER SELLADOR S10.  
Sceller toutes les unions plastique-béton: appliquer IMPRIMACIÓN SELLADOR S10.



Rellenar todo el hueco entre el hormigón y PVC con la masilla elástica SELLADOR S10.  
Then apply the SELLADOR S10 ultraelastic filler.  
Ensuite, appliquer le mastic ultra élastique SELLADOR S10.

**Regularización de las paredes**  
Render the walls  
Comment procéder au ravalement des murs

**FIX-REVOCO**

Mortero pre-mezclado de rápido fraguado, para la realización de revocos en paredes de piscinas, cumpliendo la norma EN 998.  
Pre-mixed mortar for rendering walls in swimming pools in compliance with regulation EN 998.  
Mortiers rapides déjà prédosés pour régularisation des supports selon EN 998.



FIX-REVOCO se mezcla solamente con agua.  
Mix FIX-REVOCO with water.  
Mélanger FIX-REVOCO avec de l'eau.



**Puente de unión previo a la regularización del fondo de la piscina**  
Portland-latex bonding before making the base  
Appliquer une couche de fixation préalable à l'exécution du sol

**PRIMFIX**

Aditivo para imprimaciones, recrecidos, puentes de unión y para mejorar las propiedades de adhesividad de los morteros.  
Latex for producing bonding pastes, mortars and priming.  
Aditif pour améliorer l'adhésion des mortiers.



Aplicar una lechada de agarre con: 1 parte de látex PRIMFIX + 1 parte de cemento portland.  
First apply a bond coat made with 1 part portland + 1 part PRIMFIX latex.  
Appliquer une couche de fixation constituée d'1 mesure de portland + 1 mesure de latex PRIMFIX.

**Regularización del fondo de la piscina**  
Making the base of the swimming pool  
Chape du fond de la piscine

**RECRECEM PRE-MIX**

Mortero pre-mezclado de formulación constante y fraguado rápido, para la realización del recocado del fondo de la piscina cumpliendo la norma EN 13813.  
Pre-mixed mortar with a fast drying time for rendering bases in compliance with regulation EN 13813.  
Mortier pré-mélangé à séchage rapide pour réaliser la chape du sol selon EN 13813.



Estando aún fresca la lechada, realizar el recocado de mortero del suelo del vaso con RECRECEM PRE-MIX.  
Without letting the bond coat dry, pour and level the RECRECEM PRE-MIX mortar.  
Puis, sans laisser sécher la couche de fixation, verser et niveler le mortier RECRECEM PRE-MIX.



Usar las herramientas tradicionales.  
Use traditional tools.  
Utiliser les outils traditionnels.

**Sellado estanco y flexible previo a la impermeabilización**  
Sealing before waterproofing  
Scellage préalable à l'imperméabilisation

**FIX-BANDA**

Banda auto-adhesiva con un elemento central de poliuretano ultra-flexible para el sellado de todas las esquinas.  
Ultra-elastic butyl to apply on all angles and corners in order to achieve total imperviousness.  
Butyle ultra-élastique qui s'applique dans tous les angles afin d'obtenir une imperméabilisation totale.



Retirar el papel protector y pegar FIX BANDA en todas las esquinas.  
Just withdraw the protective wrapping and fix FIX-BANDA on all corners.  
FIX-BANDA: s'applique très facilement, just retirer la protection et l'appliquer sur les jonctions de parois.

COLORES DE LA JUNTA DE COLOCACIÓN EUROCOLOR FLEX / COLOR REFERENCE FOR EUROCOLOR FLEX MORTAR JOINTS / MORTIER DE JOINTOIEMENT: RÉFÉRENCE DE COULEURS EUROCOLOR FLEX



**Impermeabilización**  
**Waterproofing**  
**Imperméabilisation**

**HIDROELASTIC**

Mortero bi-componente, pre-dosificado y ultra-elástico para la impermeabilización duradera de la piscina cumpliendo la norma EN 14891.  
Highly elastic, waterproof mortar, ideal for pools in compliance with regulation EN 14891.

Mortier imperméable et super élastique idéal pour les piscines selon EN 14891.



Aplicar HIDROELASTIC con una brocha o llana fina o...  
Apply HIDROELASTIC using a brush or flat trowel or...  
Appliquer HIDROELASTIC à l'aide d'un pinceau, d'un plattoir ou...



...con máquina de proyección. Los rendimientos son elevadísimos.  
...with a mortar spraying machine. They offer a very high performance.  
...avec un projecteur. Les rendements sont très élevés.

**Pegado flexible y seguro de la cerámica de la piscina**  
**Laying the tiles on the pool for a safe and flexible result**  
**Collage sûr et flexible du grès cérame dans la piscine**

**TECNOCOL FLEX**

Cemento cola especialmente formulado para el pegado de cerámica encima de una impermeabilización cumpliendo las normas EN 12004 y EN 12002.

Flexible, maximum-adherence, single-component concrete glue for fixing tiles onto the waterproofing in compliance with regulations EN 12004 and EN 12002.

Ciment colle mono-composant flexible pour coller le grès cérame sur l'enduit d'imperméabilisation HIDROELASTIC selon EN 12004 et EN 12002.



Pegado de la cerámica.  
Lay the ceramic tiles.  
Pose de carreaux céramiques.

**Rejuntado hidro-repelente de la cerámica de la piscina, playas y vestuarios**  
**Water-repellent grout for the tiles of the pool, pool deck and changing rooms**  
**Jointoiement imperméable de la céramique de la piscine, des plages et des vestiaires**

**JUNTATEC**

Mortero coloreado hidro-repelente y resistente a los ácidos débiles para el sellado de todas las juntas estáticas de la piscina cumpliendo la EN 13888.

Water-repellent, flexible, weak-acid-resistant mortar for sealing joints in pools in compliance with regulation EN 13888.

Jointoiement hydro-répulsif, flexible et résistant aux acides faibles selon EN 13888.



Rejuntado duradero y resistente.  
Optimal chemical resistance grouting.  
Jointoiement: durabilité et sécurité.

En piscinas de cloración salina o agua marina, rejuntar con CERPOXI.  
In salt water chlorination or sea-water pools, grout using CERPOXI.  
Pour les piscines à électrolyse au sel ou d'eau de mer, unir les joints avec du CERPOXI.

**Rejuntado antiácido y 100 % impermeable de la cerámica de la piscina**  
**100 % waterproof and acid-resistant grout for the tiles of the pool**  
**Jointoiement résistant aux acides et 100 % imperméable de la céramique de la piscine**

**CERPOXI**

Mortero anti-ácido, 100% impermeable y anti-hongos para el sellado de máxima calidad y durabilidad de las juntas de la piscina, cumpliendo la norma EN 13888.

100% waterproof, acid-resistant and anti-fungal mortar for a durable high-quality sealing of the pools joints, in compliance with regulation EN 13888.

Ciment résistant aux acides, 100 % imperméable et antifongique pour un jointoiement de haute qualité et durabilité des joints de la piscine en conformité avec la norme EN 13888.



Se mezclan los tres componentes con batidor eléctrico.  
Mix the three components using a spiral mechanical mixer.  
Composé à trois composants. Mélanger les composants avec un malaxeur électrique.



Se aplican fácilmente con la llana de goma dura FIX-ESPATULA.  
The mix is easily applied with the sharp-edged rubber trowel FIX-ESPATULA.  
Les produits sont facilement appliqués avec la taloche à joint en caoutchouc rigide FIX-ESPATULA.

**Pegado flexible y seguro de la cerámica de la playa y vestuarios**  
**How to lay the tiles on the pool deck and in the changing rooms**  
**Pose flexible et sécurisée de la céramique de la plage et des vestiaires**

**FIXAGRES FLEX**

Cemento cola flexible para el pegado de alta adherencia de la cerámica porcelánica en playas, vestuarios y duchas de piscinas cumpliendo la norma EN 12004.

Highly adhesive flexible concrete glue for laying porcelain tiles on pool decks, changing rooms and showers, in compliance with regulation EN 12004.

Ciment-colle élastique de haut pouvoir adhésif pour la pose de grès cérame sur les plages selon EN 12004.



Pegado de la cerámica de la playa con FIXAGRES FLEX.  
Lay the ceramic tiles onto the pool deck with FIXAGRES FLEX.  
Produit pour les revêtement de plages et vestiaires: FIXAGRES FLEX.

**Limpieza final de la obra**  
**Final cleanup after construction**  
**Nettoyage final du carrelage**

**GRESNET**

Ácido limpiador de todos los restos de cemento, borada, etc. No ataca los cromados, ni a los inoxidables, ni a los embellecedores de la piscina.

An acid for cleaning all excess cement, grout, etc. It doesn't harm the pool's chrome, stainless steel or embellishments.

Acide concentré pour le nettoyage de matériaux céramiques. Acide pour le nettoyage des résidus de ciment, de colle, etc. Il n'attaque ni les chromes, ni l'acier inoxydable, ni les enjoliveurs de projecteurs de piscine.



Mezclar el ácido GRESNET con 10 partes de agua.  
Mix 1 part GRESNET with 10 parts water.  
Mélanger 1 part GRESNET avec 10 parts d'eau.

Rosa Gres recomienda la utilización de productos **Fixcer** para la colocación  
Rosa Gres recommends using **Fixcer** placement products  
Rosa Gres recommande d'utiliser des produits **Fixcer** pour la pose



**COLORES DE LA JUNTA DE COLOCACIÓN CERPOXI O PROFESSIONAL PX / COLOR REFERENCE FOR CERPOXI OR PROFESSIONAL PX MORTAR JOINTS / MORTIER DE JOINTOIEMENT: RÉFÉRENCE DE COULEURS CERPOXI OU PROFESSIONAL PX**

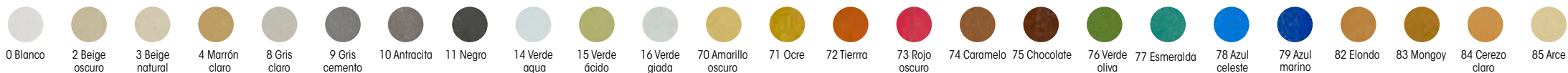





## 01 MEDICIONES

Al replantear la distancia entre muros de hormigón, hay que prever que el recrecido de mortero, el impermeabilizante, el cemento de agarre y la pieza cerámica miden aproximadamente unos 3,5 cm de grosor en cada una de las paredes, por lo que si la piscina terminada debe medir 25 m, entre muros dejaremos una distancia no inferior a 25,07 m.

Para las piscinas de competición se deben prever 1,5 cm extras en cada lado para la colocación de las placas de toque, por lo que, si pretendemos homologar una piscina de 25 m, ésta deberá tener, entre frontal y frontal terminado, una distancia de 25,03 m.

**NOTA:** En caso de usarlos, prever el espacio para los bloques S9 y su mortero de colocación.

## 01 MEASUREMENTS

When deciding on the final distance between the concrete walls, take into account the fact that the waterproofing, the screed, the cement glue and the ceramic tile are approximately 3.5 cm (1 1/7 ") thick at each of the walls. Therefore if the finished pool must be 25 m, the distance between walls cannot be less than 25.07 m.

For competition pools, an additional 1.5 cm should be taken into account to place the touchpads. Therefore, if we are trying to standardise a 25 m pool, this should have a distance of 25.03 m between both ends.

**NOTE:** If using S9 blocks, plan enough space for them and the mortar.

## 01 MEASUREMENTS

Lors du tracé de la distance entre les murs en béton, il faut prévoir le ragréage, la solution d'étanchéité liquide, la colle et la pièce céramique environ 3,5 cm d'épaisseur sur chaque mur. Si la piscine terminée doit mesurer 25 m, il est important de prévoir une distance d'au moins 25,07 m entre les murs.

Pour les piscines de compétition, il convient de prévoir 1,5 cm de plus de chaque côté pour la pose des plaques de touche. Pour homologuer une piscine de 25 m, il est important de respecter une distance de 25,03 m entre mur et mur revêtu.

**REMARQUE:** En cas d'utilisation des blocs S9, prévoir un espace suffisant et leur mortier d'installation.



## 02 ESTANQUEIDAD

La estanqueidad de la piscina **debe asegurarla el vaso de hormigón**. Cualquier tratamiento impermeabilizante es para la protección del hormigón y como una segunda garantía de estanqueidad. Por tanto el hormigón utilizado debe ser impermeable.

Una forma de asegurar la estanqueidad es colocar la junta hidro-expansiva **FUGA-STOP** en las uniones pared-suelo, pared-pared o juntas de hormigonado antes del vertido del hormigón. **FUGA-STOP** reacciona al contacto del agua, expandiendo y atajando la fuga.

Una vez ejecutado el vaso de hormigón, debe realizarse una prueba de estanqueidad. Se llena la piscina por completo y durante un periodo de 2 ó 3 semanas, se comprueba que no pierde agua.

## 02 WATERTIGHTNESS

The watertightness **must be guaranteed by the concrete tank**. Any waterproofing treatment is only an additional guarantee of watertightness. Therefore the concrete used must be waterproof.

One way of ensuring a pool is watertight is to use the expansive joint **FUGA-STOP** on the wall-floor, wall-wall and concrete joints before pouring the concrete. When **FUGA-STOP** comes into contact with the water, it reacts by expanding and containing any leaks.

A watertightness test must be carried out when the concrete tank is complete. The pool should then be filled and checked for leaks over a period of 2 or 3 weeks.

## 02 ÉTANCHÉITÉ

L'étanchéité d'une piscine **est assurée par la structure en béton**. Tout traitement imperméabilisant n'est qu'une seconde garantie d'étanchéité. Par conséquent le béton utilisé doit être imperméable.

Pour s'assurer de l'étanchéité, il faut poser un joint hydroexpansif **FUGA STOP** entre les parois et le sol, et les parois entre elles ou des joints de bétonnage avant de verser le béton. **FUGA STOP** réagit au contact de l'eau en se dilatant et empêche ainsi la fuite d'eau.

Une fois le bassin en béton terminé, il faut réaliser un test d'étanchéité. Remplir entièrement la piscine et vérifier le niveau de l'eau pendant 2 ou 3 semaines.



### 03 PREPARACIÓN DE LAS SUPERFICIES: RECRECIDOS

Eliminar cualquier resto de polvo o de aceite desencofrante del hormigón.

#### Para asegurar la adhesión del mortero:

Aplicar una lechada de agarre formada por el látex **PRIMFIX** y cemento Portland 1:1. Aplicar con brocha. Este puente de unión asegura la adhesión entre el hormigón y el mortero de recrecido.

Usar morteros de recrecido que estén específicamente formulados para ser usados en una piscina. El mortero **FIX-REVOCO** para las paredes y el mortero **RECCEM PRE-MIX** para el fondo, están formulados con arenas sílices limpias, sin arcillas expansivas, sin escorias... Son muy fáciles de usar con las herramientas habituales y además, son de rápido fraguado: a las 24 horas ya podemos ejecutar el siguiente paso.

### 03 PREPARING THE SURFACES: SCREEDS

Eliminate any dust or oil residue from the concrete.

#### To ensure the adhesion of the mortar:

Apply a bonding paste made of 1:1 **PRIMFIX** latex and Portland cement. Apply with a brush. This bond ensures adhesion between the concrete and the screed.

Use a screed mix that is specifically formulated to be used in swimming pools. The **FIX-REVOCO** mortar for walls and the **RECCEM PRE-MIX** mortar for floors are formulations containing clean silica sands, devoid of expansive clays, slags, etc. They are very easy to use with everyday tools and have the added advantage of setting quickly. After 24 hours we can perform the next step.

### 03 PRÉPARATION DES SUPPORTS: SURÉLÉVATIONS

Éliminer les restes de poussière ou d'huile de décoffrage du béton.

#### Pour assurer l'adhérence du mortier:

Appliquer une couche de ciment de prise formée par du latex de type **PRIMFIX** et du ciment Portland 1:1. Appliquer à l'aide d'un pinceau. Cette couche permet d'assurer la liaison et l'adhérence entre le béton et le mortier de surélévation.

Utiliser des mortiers de ragréage spécifiquement indiqués pour une utilisation en piscine. Le mortier **FIX-REVOCO** pour les parois et le mortier **RECCEM PRE-MIX** pour le fond sont à base de sables silicieux, sans argile expansive, sans résidus... Ils sont très faciles à utiliser avec des outils habituels. De plus, ils prennent très vite: après 24 heures nous pouvons réaliser l'étape suivante.



### 04 IMPERMEABILIZACIÓN Y PEGADO DE LAS PLAQUETAS

El hormigón sufre movimientos estructurales de presión, compresión y retracción durante todo su ciclo de vida. Estos pequeños movimientos pueden perjudicar la estanqueidad de la piscina. Una forma sencilla y económica de tener un segundo sello de estanqueidad es impermeabilizar las paredes, el fondo y el rebosadero con la membrana cementosa elástica **HIDROELASTIC**. Pasados un par de días, pegar la cerámica con el cemento cola flexible clase C2 T S1 **TECNOCOL FLEX** apto para pegar sobre impermeabilizaciones. Utilizar una llana dentada de diente 10 mm. Recomendamos usar la técnica del doble encolado.

Cuando por temas presupuestarios no es posible una impermeabilización extra, pegaremos la cerámica directamente sobre el mortero de recrecido. Sobre este mortero ya fraguado y seco, pegar la cerámica con el cemento cola clase C2 TE apto para inmersión **FIXAGRES FLEX**. Usar una llana dentada de 10 mm. Recomendamos usar la técnica del doble encolado.

### 04 WATERPROOFING AND LAYING THE CERAMIC TILES

Concrete undergoes structural movements due to pressure, compression and shrinkage throughout its life cycle. These small movements can compromise the watertightness of pools. One simple, inexpensive way of applying a second watertight seal is by waterproofing the walls, floor, overflow outlet and channel using the elastic mortar **HIDROELASTIC**. After a couple of days, lay the ceramic tiles with **TECNOCOL FLEX**, a C2 T S1 cement, suitable for applying on waterproof layers. Use a 10 mm notched trowel. We recommend using the double application technique.

If owing to budget constraints it is not possible to apply an extra waterproofing, set the tiles directly on the screed mortar. Once this mortar is cured and dry, set the tiles using **FIXAGRES FLEX** - C2 TE cement. Use a 10 mm notched trowel. We recommend using the double application technique.

### 04 IMPERMÉABILISATION ET POSE DES PLAQUETTES CÉRAMIQUES

Le béton présente des mouvements structurés dus à la pression, à la compression et à la rétraction tout au long de son cycle de vie. Ces mouvements mineurs peuvent endommager l'étanchéité de la piscine. Une façon simple d'obtenir une deuxième couche étanche consiste à imperméabiliser les parois, le fond et le déversoir à l'aide d'une membrane cimentuse élastique de type **HIDROELASTIC**. Après quelques jours, poser la céramique à l'aide d'un ciment colle flexible de classe C2 T S1 de type **TECNOCOL FLEX** permettant de coller sur les imperméabilisations. Utiliser une truelle dentée de 10 mm. Nous recommandons d'utiliser la technique du double encollage.

Si le budget ne permet pas de réaliser une seconde imperméabilisation, nous collerons la céramique directement sur le mortier de ragréage. Sur le mortier ayant pris et étant sec, coller la céramique à l'aide d'un ciment colle de classe C2 TE permettant l'immersion de type **FIXAGRES FLEX**. Utiliser une truelle dentée de 10 mm. Nous recommandons d'utiliser la technique du double encollage.



## 05 DISTRIBUCIÓN GEOMÉTRICA DE LAS PIEZAS EN LA PISCINA

### ANTES DE LA COLOCACIÓN: MARCACIÓN DE LA PISCINA

- 1 Se colocan en los cuatro ángulos, las piezas especiales de esquina del tipo de reborde elegido. Fig. 1
- 2 En todo el perímetro, y a partir de las piezas de las esquinas, se trazan marcas cada metro lineal. Fig. 2
- 3 Se puede colocar una pieza cada metro lineal que sirva de guía.
- 4 Bajaremos líneas verticales por las paredes marcándolas con un cordel coloreado (azulete o similar). Fig. 3
- 5 Las líneas se hacen cuadrar por el fondo. De esta forma el vaso quedará reticulado y será una guía perfecta para la colocación de la cerámica. Fig. 4

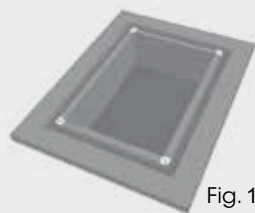

Fig. 1

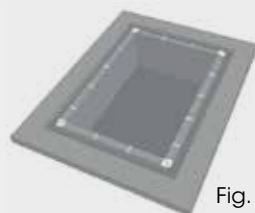

Fig. 2

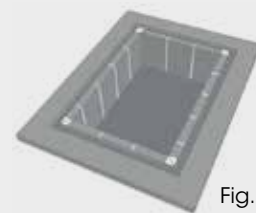

Fig. 3

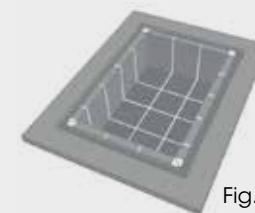

Fig. 4

- 6 Marcaremos, cuando las hubiere, las líneas de señalización de las calles, tanto en las paredes de salida como en el fondo.
- 7 Las piezas de formato 119 x 244 se colocarán a razón de 4 piezas por metro lineal en el largo de la pieza y de 8 piezas por metro lineal en el ancho de la misma. Las de formato 244 x 494 irán a razón de 2 piezas en el largo por 4 en el ancho. En ambos casos quedará una junta de aproximadamente 6 mm.

## 05 DISTRIBUTION OF POOL COMPONENTS

### BEFORE INSTALLATION: MARKING THE POOL

- 1 Place the special corner pieces, according to the type of perimeter edge chosen, in the four corners. Fig. 1
- 2 Draw marks every linear metre around the whole perimeter, using the corner pieces as a starting point. Fig. 2
- 3 A piece can be placed every linear metre to serve as a guide.
- 4 Mark coloured vertical lines down the side of the walls (blue marking paint or similar). Fig. 3
- 5 Crisscross the lines on the tank bottom. The tank will therefore form a grid pattern and serve as a perfect guide for laying the ceramic pieces. Fig. 4

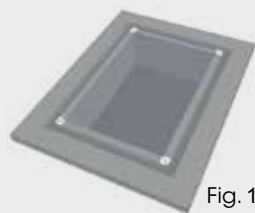

Fig. 1

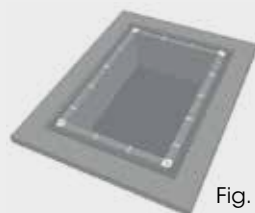

Fig. 2

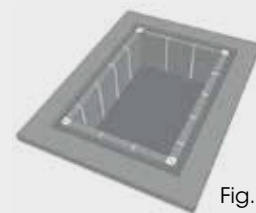

Fig. 3

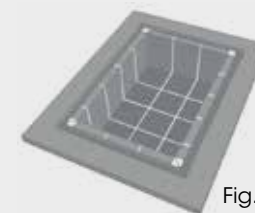

Fig. 4

- 6 If necessary, mark the lines for the lanes on both the walls and the bottom of the pool.
- 7 Place the 119 x 244 parts in a ratio of 4 pieces per linear metre lengthways and 8 pieces across. The 244 x 494 ones are placed in a ratio of 2 pieces per linear metre lengthways and 4 pieces across. In both cases the joint between pieces will be approximately 6 mm.

## 05 DISTRIBUTION GÉOMÉTRIQUE DES PIÈCES DANS LA PISCINE

### AVANT LA POSE: MARQUAGE DE LA PISCINE

- 1 Posez sur les quatre angles les pièces spéciales d'angle du type de débordement choisi. Fig. 1
- 2 Tracez des marques tous les mètres linéaires à partir des pièces des angles sur tout le périmètre. Fig. 2
- 3 Il est possible de poser une pièce tous les mètres linéaires pour servir de repère.
- 4 Tracez vers le bas des lignes verticales sur les parois en les marquant à l'aide d'un cordeau coloré (bleu ou similaire). Fig. 3
- 5 Au fond, les lignes se croisent dans un quadrillage qui fera un guide parfait pour la pose de la céramique. Fig. 4



5



6

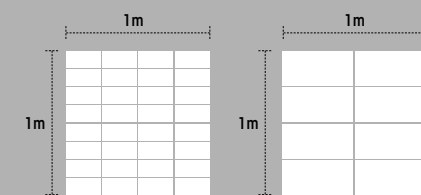

32 piezas / pieces / pièces 8 piezas / pieces / pièces  
119 x 244 mm 244 x 494 mm

junta / joint / joint: 6 mm

7



## 06 INICIO DEL ALICATADO

- 1 Empezaremos alicatando las paredes, siguiendo las líneas coloreadas trazadas previamente.
- 2 En los paramentos verticales se pueden utilizar crucetas, pinchándolas entre las piezas tal como se observa en la fotografía.
- 3 Una vez revestidas todas las paredes, empezaremos la colocación de las piezas del fondo del vaso.
- 4 En el pavimento, no es necesaria la utilización de crucetas. El ajuste final de las piezas puede hacerse a mano, siguiendo siempre las marcas trazadas.

## 06 STARTING THE TILING

- 1 Begin tiling the walls following the coloured lines previously marked.
- 2 Cross-pieces can be used on the verticals, inserting them between the pieces as shown in the photograph.
- 3 Once all the walls have been tiled, place the parts on the bottom of the tank.
- 4 Cross-pieces do not need to be used for the flooring as final adjustment of the pieces can be carried out by hand, always following the lines.

## 06 DÉBUT DU CARRELAGE

- 1 Commencer par la pose des parois, en suivant les lignes colorées tracées au préalable.
- 2 Pour la pose verticale, il est possible d'utiliser des croisillons en les piquant entre les pièces tel que montré sur la photographie.
- 3 Une fois toutes les parois revêtues, poursuivre la pose des pièces du fond du bassin.
- 4 L'utilisation du croisillon n'est pas nécessaire pour le sol. L'emboîtement final des pièces peut être effectué à la main, en suivant toujours les marques tracées.



## 07 REJUNTADO

Otra forma de mejorar la estanqueidad del vaso es usando el mortero epoxídico 100% estanco, flexible y antiácido de clase RG **CERPOXI**.

Una muy buena alternativa es la que nos ofrece el mortero coloreado **JUNTATEC**. Este mortero es resistente a los ácidos débiles y solo con un 2% de absorción residual.

**IMPORTANTE:** Antes del llenado de agua, es necesario esperar entre 5-7 días. En piscinas de cloración salina o agua salada usar **CERPOXI**.

## 07 WATERPROOF GROUT

Another way of improving the watertightness of the tank is to use **CERPOXI**, a fully watertight, flexible and acid-proof mortar.

The **JUNTATEC** coloured mortar is a very good alternative. It is resistant to weak acids and has a residual absorption value of just 2%.

**IMPORTANT:** Wait for 5-7 days before filling with water. In salt water chlorination or salt-water pools, use **CERPOXI**.

## 07 JOINTOIEMENT IMPERMÉABLE

Une autre solution technique permettant d'améliorer l'imperméabilisation du bassin est d'utiliser le mortier époxydique 100 % étanche, flexible et antiacide **CERPOXI** de classe RG.

Le mortier coloré de classe CG2 **JUNTATEC** nous offre une très bonne solution. Ce dernier résiste aux acides faibles et n'a que 2 % d'absorption résiduelle.

**IMPORTANT:** Avant de remplir d'eau, vous devez attendre entre 5 et 7 jours. Pour les piscines à électrolyse au sel ou d'eau salée, utiliser du **CERPOXI**.



**08** JUNTAS  
DE DILATACIÓN

Hay que respetar las juntas estructurales de la piscina (si las hay) y realizar juntas de dilatación cada 25 m<sup>2</sup> y/o 5 metros lineales como máximo.

Para su sellado usen el cordón de espuma de polietileno **SELLALASTIC FOAM** como relleno de la junta y la masilla elástica tipo **SILICONA NEUTRA** como sellado final. Esperar entre 5-7 días antes de llenar la piscina.

**08** EXPANSION  
JOINTS

The structural joints of the pool, when there are any, have to be respected. Place expansion joints every 25 square meters and/or 5 linear meters at most.

For the sealing, use **SELLALASTIC FOAM** as grouting and **SELLASTIC** elastic filler as the final sealing. Wait for 5-7 days before filling pool.

**08** JOINTS  
DILATATION

Il est important de respecter les joints structurels de la piscine (s'ils existent) et de réaliser des joints de dilatation tous les 25 m<sup>2</sup> et/ou 5 mètres linéaires maximum.

Pour le scellage, utilisez le cordon **SELLALASTIC FOAM** comme remplissage du joint et le mastic de type **SILICONA NEUTRA** comme scellage final. Attendre 5 à 7 jours avant de remplir la piscine.





### LIMPIEZA DE LOS RESTOS DE MATERIAL DE REJUNTADO

Solo en el caso de tener restos de material de rejuntado muy adheridos:

- Si hemos usado **JUNTATEC**: pasados 3 días mínimo, utilizaremos el ácido limpiador **GRESNET** diluido con agua en una proporción ácido: agua del 1:10.
- Si hemos usado **CERPOXI**: pasadas 24 horas limpiaremos con el decapante especial para eliminar restos de epoxi **EPOXI CLEANER**.

### CLEANING GROUT RESIDUE

Only in the case of very encrusted residue, use:

- If we have used **JUNTATEC**: after a minimum of 3 days have passed, we should use the acid cleaner **GRESNET**, diluted with water in an acid:water ratio of 1:10.
- If we have used **CERPOXI**: after 24 hours have passed, we should clean it with the special paint stripper **EPOXI CLEANER** to remove any remains.

### NETTOYAGE DU SURPLUS DU PRODUIT DE JOINTOIEMENT

Seulement dans les cas où nous trouverons des restes de joint très adhésifs, nous utiliserons:

- Si nous avons utilisé **JUNTATEC**: après 3 jours minimum, nous utiliserons un acide nettoyant **GRESNET** dilué dans de l'eau avec un ratio acide-eau de 1:10.
- Si nous avons utilisé **CERPOXI**: après 24 heures, nous nettoierons avec un décapant spécial **EPOXI CLEANER** pour éliminer les restes.

### TIPO DE CERÁMICA A COLOCAR

En todos los casos colocaremos gres porcelánico.

### TYPE OF CERAMIC TILES TO LAY

Always use porcelain stoneware tiles.

### JUNTAS DE DILATACIÓN

Son especialmente necesarias en las piscinas al aire libre. Todo el vaso estará cuadrículado con juntas de dilatación en paños de 25 m<sup>2</sup> y/o 5 metros lineales como máximo. En la zona del reborde superior de la piscina, se realizará la junta de dilatación cada metro lineal.

### EXPANSION JOINTS

These are particularly necessary in open-air pools. The whole tank should be checkered with expansion joints in sections of 25 square meters and/or 5 linear meters at most. In the area of the upper edge of the pool, the expansion joints should be placed at every linear metre.

### EL NIVEL DEL AGUA

La piscina no se debe vaciar nunca en invierno. El nivel del agua se mantendrá a la altura de la rejilla. El agua funciona como un cojín térmico, de forma que amortigua las dilataciones y contracciones debidas a los cambios de temperatura.

### WATER LEVEL

The pool should never be emptied in winter. The water level should be maintained at the level of the overflow drain. The water acts like a thermal pillow, absorbing the expansion and contractions due to changes in temperature.

### EL HIELO

Para evitar la presión del hielo contra las paredes, colocaremos elementos elásticos (neumáticos, esponjas, plásticos esponjosos, porexpan...) flotando dentro de la piscina junto a las paredes laterales.

### ICE

To avoid pressure from ice against the walls, there should be elastic components (such as tyres, sponges, spongy plastics, porexpan...) floating in the pool next to the sidewalls.

### MANTA TÉRMICA

Es muy recomendable proteger durante el invierno toda la piscina con una manta térmica.

### THERMAL COVER

Recommended to protect the pool during winter.

### TYPE DE CARRELAGE À POSER

Dans tous les cas, il convient de poser du grès cérame.

### JOINTS DE DILATATION

Ils sont particulièrement recommandés pour les piscines extérieures. Le bassin devra être quadrillé avec des joints de dilatation sur des pans de 25 m<sup>2</sup> et ou 5 mètres linéaires au maximum. Il est conseillé de réaliser des joints de dilatation tous les mètres linéaires dans la partie du rebord supérieur de la piscine.

### LE NIVEAU DE L'EAU

Ne jamais vider la piscine en hiver. Le niveau de l'eau devra être maintenu à hauteur de la grille. L'eau fonctionne comme un coussin thermique, de telle sorte qu'elle amortit les dilatations et les rétractions dues aux changements de température.

### LE GEL

Pour éviter la pression du gel contre les parois, il convient de poser des éléments élastiques (pneumatiques éponges, plastiques spongieux, porexpan...) flottant dans la piscine à côté des parois latérales.

### COUVERTURE THERMIQUE

Il est conseillé de protéger la piscine pendant l'hiver à l'aide d'une couverture thermique.

## RECOMENDACIONES PARA LAS PISCINAS EXTERIORES

## OPEN-AIR POOL RECOMMENDATIONS

## RECOMMANDATIONS POUR LES PISCINES EXTÉRIEURES





01

Se proyecta el hormigón formando las paredes, fondo de vaso y murete perimetral, teniendo en cuenta que hay que dejar una zona de recepción del bloque S9 que se ajuste a las medidas del mismo.

The concrete is cast, forming the walls, tank bottom and perimeter low wall, leaving a reception area in which to place the S9 block that will have the same measurements as the block.

Le béton est projeté en formant les parois, le fond du bassin et le mur périphérique, en tenant compte de la zone de réception du bloc S9, adaptée aux dimensions de ce dernier.



02

Para simplificar el proceso de hormigonado, éste se puede realizar en dos tiempos. Primero se deja una zona de recepción plana con unas esperas de hierro y colocamos la junta hidroexpansiva **FUGA STOP MINI** en el medio de las esperas. Posteriormente terminaremos por rellenar el talón (después del paso 5). Pegamos la junta con **MASTIC MS**.

To simplify the process of concreting, this may be done in two stages. First we prepare a flat reception area with some reinforced iron bars and we then place the hydro-expansive joint **FUGA STOP MINI** in between the reinforced bars. Then it is finished by filling the gap (after step 5). Glue the joint with **MASTIC MS**.

Pour simplifier le processus de bétonnage, il est possible de le réaliser en deux temps. Tout d'abord, il faut laisser libre une surface de réception plate équipée de fers d'attente et installer un joint hydro-expansif de type **FUGA STOP MINI** au milieu des fers d'attente. Nous terminerons ensuite cette tâche en remplissant le talon (après l'étape 5). Nous collons le joint avec le **MASTIC MS**.



03

Empezamos colocando las piezas de las esquinas con un nivel láser. Colocamos cordeles entre ellas. A continuación colocamos los bloques S9 entre esquina y esquina.

We start by positioning the pieces of the corners using a laser level. We place twine between them. Then we position the S9 blocks between corner and corner.

Nous commençons par installer les pièces des coins à l'aide d'un niveau laser. Nous installons des ficelles entre les coins. Ensuite, nous installons les blocs S9 entre les coins.



04

Se colocan los bloques de hormigón con mortero aditivado con el látex **PRIMFIX** a razón de 1 parte de **PRIMFIX** por 2 partes de agua.

**Nota:** En piscinas de agua salada, consultar nuestro departamento técnico.

The concrete blocks are positioned with mortar to which the latex type additive **PRIMFIX** has been added with 1 part **PRIMFIX** to 2 parts water.

**Note:** For salt water pools, consult our technical department.

Il faut installer les blocs de béton à l'aide de mortier enrichi en latex **PRIMFIX** à raison d'1 mesure de **PRIMFIX** pour 2 mesures d'eau.

**Remarque:** Pour les piscines au sel, consultez notre service technique.



05

Es imprescindible poner mortero también en la junta entre los bloques. Una vez colocados los bloques rellenamos el talón posterior con hormigón.

It is also essential to place mortar in the joint between the blocks. Once the blocks have been positioned the back gap is filled with concrete.

Il est indispensable de mettre également du mortier dans le joint se situant entre les blocs. Une fois les blocs installés, nous remplissons le talon arrière avec du béton.



06

Usando los bloques como guía, realizamos el recrecido de mortero de las paredes con el mortero de calidad constante y de secado rápido **FIX-REVOCO**.

Using the blocks as a guide, the mortar screed of the walls is performed with **FIX-REVOCO**, a quick-drying mortar of uniform quality.

En utilisant les blocs comme repères, nous procédons au ragréage des murs à l'aide d'un mortier de qualité constante et à prise rapide **FIX-REVOCO**.



07

Realizamos la impermeabilización del vaso con el impermeabilizante elástico **HIDROELASTIC** donde vaya a ir baldosa encima. Y la impermeabilización de la canal con el impermeabilizante **HIDROFIX**.

The waterproofing of the tank is carried out with **HIDROELASTIC** elastic waterproofing, on top of which the tiles will be placed. And the waterproofing of the channel is done using **HIDROFIX** waterproofing.

Nous imperméabilisons le bassin en appliquant le imperméabilisant élastique **HIDROELASTIC** à l'endroit où seront posées les dalles. Nous imperméabilisons également la gouttière au moyen de l'imperméabilisant **HIDROFIX**.



08

Usamos el cemento cola de clase C2 T S1 especial para pegar gres porcelánico encima de la impermeabilización **TECNOCOL FLEX**. Para el rejuntado usaremos **JUNTATEC** o **CERPOXI**.

Use **TECNOCOL FLEX**, an adhesive cement type C2 T S1, for adhering the porcelain stoneware on top of the waterproofing. Perform the grouting with **JUNTATEC** or **CERPOXI**.

Toujours utiliser un ciment colle **TECNOCOL FLEX** de classe C2 T S1 adéquat pour coller le grès cérame sur l'imperméabilisation. Pour le scellement de joints, nous utiliserons le **JUNTATEC** ou le **CERPOXI**.





### COLOCACIÓN DE LOS DRENAJES EN LOS BLOQUES S9

Recomendamos la colocación de tubos de drenaje de entre 3" y 4" cada 4 ml (4)

Dejar un espacio entre el tubo de PVC y la estructura de hormigón que sellaremos con masilla de poliuretano "Sellador S10" (7)

Realizaremos los agujeros en los bloques S9 con taladro y corona de dimensiones unos 4 cm superior al diámetro del tubo

Colocaremos los bloques S9 y sellaremos el espacio entre el tubo y el bloque con "Sellador S10" (6)

Impermeabilizaremos el canal con la impermeabilización cementosa "Hidrofix" haciendo que esta penetre en el tubo (4) (línea amarilla)

### PLACING DRAINS IN S9 BLOCKS

We recommend the placement of 3" to 4" drainage pipes every 4 lm (4)

Leave a space between the PVC pipe and the concrete structure which will be sealed with "Sellador S10" polyurethane putty (7)

Use a drill to make holes in the S9 blocks about 4 cm larger than the diameter of the pipe

Place the S9 blocks and seal the space between the pipe and block with "Sellador S10" (6)

Waterproof the channel with "Hidrofix" mortar ensuring this penetrates the tube (4) (yellow line)

### INSTALLATION DES DRAINS SUR LES BLOCS S9

Nous vous recommandons d'installer des tuyaux de drainage mesurant entre 3" et 4" tous les 4 ml (4)

Laissez un espace entre le tuyau de PVC et la structure en béton qui sera scellé avec un mastic polyuréthane "Sellador S10" (7)

Nous réalisons des trous dans les blocs S9 avec une perceuse et une cloche de dimensions supérieures à 4 cm par rapport au diamètre du tuyau

Nous installons les blocs S9 et scellons l'espace entre le tuyau et le bloc à l'aide du "Sellador S10" (6)

Nous imperméabilisons la gouttière avec le ciment d'étanchéité "Hidrofix" en le faisant pénétrer dans le tuyau (4) (ligne jaune)

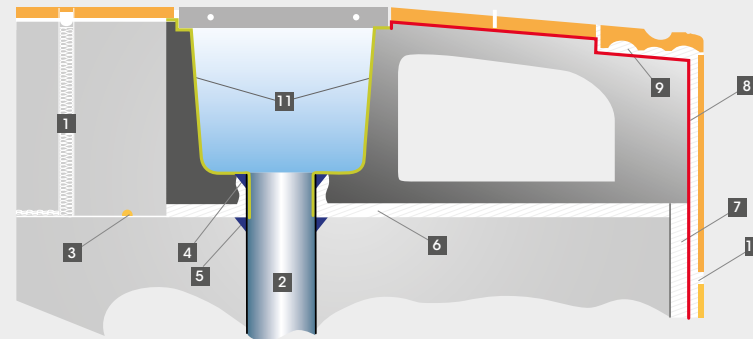

- 1 Junta de dilatación imprescindible en todo el perímetro de la piscina
- 2 Tubo de drenaje
- 3 **FUGA-STOP MINI** Junta hidroexpansiva
- 4 **SELLADOR S10** Sellado estanco con poliuretano
- 5 **SELLADOR S10** Sellado estanco con poliuretano
- 6 **PRIMFIX** Mortero aditivado con látex
- 7 **FIX-REVOCO** Mortero de recreado
- 8 **HIDROELASTIC** Impermeabilización
- 9 **TECNOCOL FLEX** Ultra adhesivo para el pegado de la cerámica
- 10 **JUNTATEC** o **CERPOXI**
- 11 **HIDROFIX** Impermeabilización del canal

**NOTA:** Antes de aplicar el SELLADOR S10, frotar el tubo con disolvente para PVC; aplicar en el hormigón la imprimación SELLADOR S10; esperar entre 1-4 horas y aplicar SELLADOR S10 presionando contra el PVC y el hormigón.

- 1 Expansion joint - essential around the entire perimeter of the pool
- 2 Drainage pipe
- 3 **FUGA-STOP MINI** hydro-expansive joint
- 4 **SELLADOR S10** Watertight sealing with polyurethane
- 5 **SELLADOR S10** Watertight sealing with polyurethane
- 6 **PRIMFIX** Mortar with latex additive
- 7 **FIX-REVOCO** Screed mortar
- 8 **HIDROELASTIC** Waterproofing
- 9 **TECNOCOL FLEX** Ultra adhesive ceramic glue
- 10 **JUNTATEC** or **CERPOXI**
- 11 **HIDROFIX** Channel waterproofing

**NOTE:** Before applying SELLADOR S10, rub the pipe with S10 sealant primer; apply SELLADOR S10 primer to the concrete; wait 1-4 hours and apply SELLADOR S10 by pressing against the PVC and the concrete.

- 1 Joint de dilatation nécessaire sur tout le périmètre de la piscine
- 2 Tuyau de drainage
- 3 **FUGA-STOP MINI** Joint hydro-expansif
- 4 **SELLADOR S10** Scellage mastic polyuréthane
- 5 **SELLADOR S10** Scellage mastic polyuréthane
- 6 **PRIMFIX** Mortier enrichi en latex
- 7 **FIX-REVOCO** Mortier prêt à gâcher
- 8 **HIDROELASTIC** Étanchéité
- 9 **TECNOCOL FLEX** Ciment colle flexible à adhérence maximale pour le collage de grès cérame
- 10 **JUNTATEC** ou **CERPOXI**
- 11 **HIDROFIX** Étanchéité de la gouttière

**REMARQUE:** Avant d'appliquer SELLADOR S10, appliquez un apprêt pour mastic S10 sur le tuyau, appliquez l'apprêt SELLADOR S10 sur le béton, attendez entre 1-4 heures et appliquez SELLADOR S10 en appuyant contre le PVC et le béton.

**EL SISTEMA 9 SE PUEDE UTILIZAR TANTO PARA REALIZAR PISCINAS RECTAS COMO PISCINAS CURVAS**

**SYSTEM 9 CAN BE USED FOR BOTH STRAIGHT AND CURVED SWIMMING POOLS**

**LE SYSTÈME 9 PEUT AUSSI BIEN ÊTRE UTILISÉ POUR CONSTRUIRE DES PISCINES DE FORME DROITE QUE DES PISCINES DE FORME ARRONDIE**

## S9 ERGO / S9 FINLANDÉS FINNISH FINLANDAIS - HORYZON / S9 PRESTIGE

Son muchas las piscinas de uso público, municipales, de cámpings, hoteles, comunidades de vecinos, que requieren una puesta a punto para subsanar desperfectos y, sobre todo, adaptarse a la normativa vigente en cuanto a seguridad. Es por eso que últimamente la rehabilitación de viejas piscinas skimmer para convertirlas en desbordantes - mucho más higiénicas y seguras - ha adquirido gran importancia.

¿Cómo hacerlo de manera rápida, eficiente y económica? Utilizando los bloques del Sistema 9 de Rosa Gres. Con el Sistema 9 conseguimos una rápida ejecución del canal desbordante. Veamos cómo hacerlo paso a paso.

### Proyecto:

Rehabilitación de una piscina Skimmer para convertirla en desbordante con los bloques S9 Ergo. Cámping Ridaura (Llagostera - España)

There are public, municipal, campsite, hotel and residential pools that require an overhaul to correct flaws and to adapt them to new safety regulations. That is why renovating old skimmer pools to turn them into infinity pools - much more hygienic and safe - has now become so important.

Yet how can this be done quickly, efficiently and economically? By using System 9 blocks from Rosa Gres. With System 9, the overflow channel can be made very quickly. Here is how to do this step by step.

### Project:

Renovating a skimmer pool to turn it into an infinity pool with Ergo S9 blocks. Ridaura Camp site (Llagostera - Spain)

Beaucoup de piscines publiques (municipales, campings, hôtels, résidences), requièrent une mise au point pour améliorer les imperfections et, surtout, s'adapter à la réglementation en vigueur relative à la sécurité. C'est pour cette raison que, ces dernières années, la réhabilitation de vieilles piscines à skimmer pour en faire des piscines à débordement - beaucoup plus sûres et hygiéniques - a acquis une grande importance.

Comment y procéder de façon rapide, efficace et économe? En utilisant les blocs du Système 9 de Rosa Gres. Le Système 9 permet de réaliser rapidement le canal de débordement. Nous allons voir comment procéder étape par étape.

### Projet:

Réhabilitation d'une piscine à skimmer pour en faire une piscine à débordement grâce aux blocs S9 Ergo. Camping Ridaura (Llagostera - Espagne)

## ANTES / BEFORE / AVANT



## DESPUÉS / AFTER / APRÈS





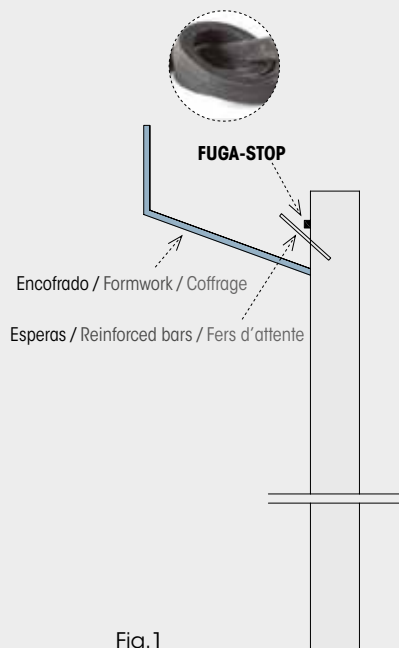

Fig.1

## 01 PREPARACIÓN DE LA SUPERFICIE

Eliminamos el coronamiento antiguo. Cavamos una zanja alrededor del vaso para pasar las canalizaciones del sistema desbordante. Colocamos las esperas clavadas con resina epoxídica o taco químico.

Colocamos una junta hidroexpansiva **FUGA-STOP**, asegurándonos que habrá un mínimo de 7 cm de hormigón en todo su alrededor.

## 01 PREPARATION OF THE SURFACE

We remove the old coping. We dig a trench around the tank in which to pass the pipes of the overflow system. We place the reinforced bars fixed with epoxy resin or chemical wadding.

Place the hydro-expansive joint **FUGA-STOP**, ensuring that there will be at least 7 cm of concrete all around it.

## 01 PRÉPARATION DE LA SURFACE

Nous retirons l'ancien couronnement. Nous creusons une tranchée autour du bassin pour faire passer les canalisations du système de débordement. Nous installons les fers d'attente cloués avec de la résine époxydique, ou cheville chimique.

Nous installons un joint hydro-expansif **FUGA-STOP** en nous assurant de disposer d'au minimum 7 cm de béton tout autour.



## 02 REALIZAR LA BASE

Montamos los hierros que armarán la cartela, dejando ya las esperas para el talón posterior. Realizamos la base con hormigón para poder colocar los bloques S9. Junto a las esperas del talón posterior pondremos nuevamente la junta hidroexpansiva **FUGA-STOP MINI**.

En algunos casos, al encontrarnos con un muro suficientemente ancho, no será necesario realizar la base, aunque siempre es necesario realizar el talón posterior.

## 02 MAKE THE BASE

We set up irons that will reinforce the bracket, leaving the reinforced bars for the back gap. We make the base with concrete in order to be able to place the S9 blocks. Along with the reinforced bars of the back gap we will once again place the concrete joint **FUGA-STOP MINI**.

In some cases, when we find there is a sufficiently wide wall, the base will not need to be built, although it is always necessary to make the back gap.

## 02 RÉALISER LA BASE

Nous montons les fers qui serviront de base à la console, laissant de côté les fers en attente pour le talon arrière. Nous réalisons la base avec du béton pour pouvoir installer les blocs S9. Nous installerons à nouveau le joint hydro-expansif **FUGA-STOP MINI** en même temps que les fers en attente du talon arrière.

Dans les cas où nous nous retrouverons face à un mur suffisamment large, il ne sera pas nécessaire de réaliser la base, bien qu'il soit toujours nécessaire de réaliser le talon arrière.

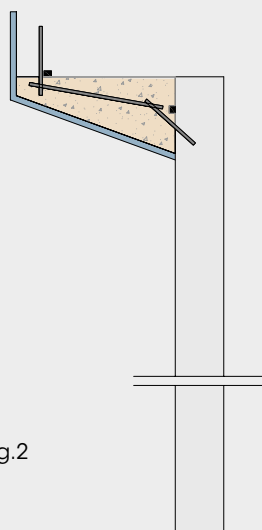

Fig.2



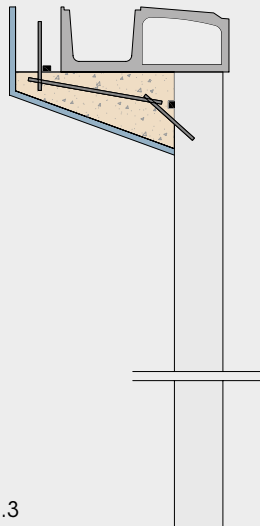

Fig.3

### 03 COLOCACIÓN DE LOS BLOQUES S9

Ver detalles de colocación de los bloques S9 en la página 120.

### 03 PLACING THE S9 BLOCKS

See details on how to place the S9 blocks on page 120.

### 03 INSTALLATION DES BLOCS S9

Voir détails d'installation des blocs S9 à la page 120.



### 04 RELLENAR EL TALÓN POSTERIOR

Rellenamos con hormigón el talón posterior y realizamos, si es necesario, el recrecido de las paredes. En la foto se puede apreciar lo recto que queda el canal desbordante, lo que nos facilitará la colocación de las piezas cerámicas del borde de la piscina.

### 04 FILLING IN THE BACK GAP

Fill the back gap with concrete, and, if necessary, screed the walls. In the picture you can see how straight the overflowing channel should be, which will facilitate laying the tiles at the edge of the pool.

### 04 REMPLIR LE TALON ARRIÈRE

Nous remplissons le talon postérieur avec du béton et, si nécessaire, nous réalisons le ragréage des parois. On peut apercevoir sur la photo le tracé droit du canal de débordement, ce qui facilitera l'installation des pièces céramiques du bord de la piscine.

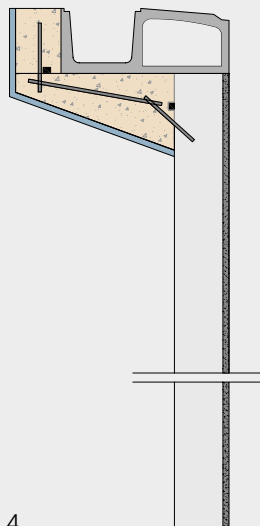

Fig.4

### ELEVACIÓN DEL FONDO DEL VASO

Por comodidad, seguridad y ahorro de agua, las piscinas ahora se hacen menos profundas que antes, con lo que en una rehabilitación de una piscina antigua seguramente convendrá elevar el fondo del vaso. Además, se puede aprovechar este recrecido para pasar las canalizaciones de los nuevos impulsores.

### RAISING THE BOTTOM OF THE TANK

For comfort, safety and water saving, swimming pools are now shallower than before, so it would probably be a good idea to raise the bottom of the tank when renovating an old pool. We can also pass the pipes of the new fittings through this screeding.

### ÉLEVATION DU FOND DU BASSIN

Pour des questions de confort, de sécurité et d'économie d'eau, les piscines sont de nos jours moins profondes qu'avant. Par conséquent, la réhabilitation d'une vieille piscine exigera probablement l'élévation du fond du bassin. De plus, il est possible de profiter de cette surélévation pour faire passer les canalisations des nouveaux moteurs.





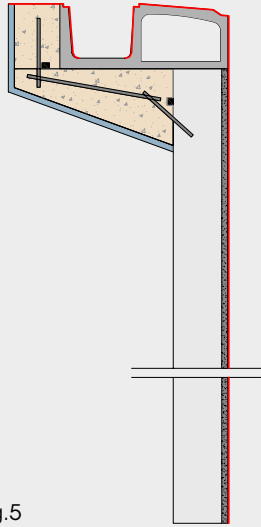

Fig.5

### 05 IMPERMEABILIZACIÓN

Impermeabilizamos los bloques y el vaso con el impermeabilizante cementoso elástico **HIDROELASTIC**. Y el interior del canal desbordante con el impermeabilizante **HIDROFIX**.

Cuando el soporte está húmedo (y no podemos esperar a que se seque completamente) procederemos a aplicar una primera capa de **HIDROFIX**, reforzándola con la malla de fibra de vidrio **NET-HIDRO 80**. Cuando se seque continuaremos con las 2 capas de **HIDROELASTIC**.



### 05 WATERPROOFING

We waterproof the blocks and the tank with the elastic cementitious waterproofing **HIDROELASTIC**. The inside of the overflow channel is waterproofed with **HIDROFIX** waterproofing.

When the surface is still wet (and we cannot wait for it to dry completely) we will apply a first coat of **HIDROFIX**, reinforcing it with the fiberglass mesh **NET-HIDRO 80**. When it dries we will continue with the 2 coats of **HIDROELASTIC**.



### 05 IMPERMÉABILISATION

Nous imperméabilisons les blocs et le bassin avec le imperméabilisant à base de ciment élastique **HIDROELASTIC**. Nous réalisons la même opération à l'intérieur du canal de débordement avec le imperméabilisant **HIDROFIX**.

Si le support est humide (et qu'on ne peut pas attendre qu'il sèche complètement), nous appliquerons une première couche d'**HIDROFIX**, en la consolidant avec une maille en fibre de verre **NET-HIDRO 80**. Nous continuerons avec les 2 couches d'**HIDROELASTIC** quand le support sera sec.

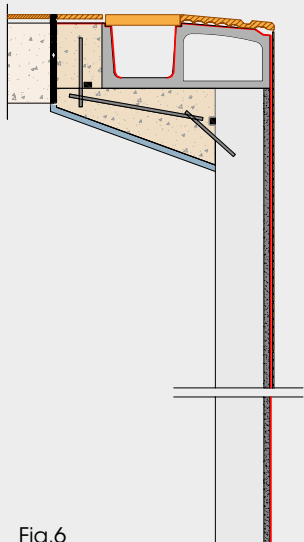

Fig.6

### 06 COLOCACIÓN DE LA CERÁMICA

Colocaremos el gres con el cemento cola de clase C2 T S1 **TECNOCOL FLEX**, adecuado para pegar gres porcelánico sobre impermeabilización. Rejuntaremos con **CERPOXI** o **JUNTATEC**.



### 06 LAYING THE CERAMIC TILES

We will lay the tiles with **TECNOCOL FLEX**, a glue cement of the type C2 T S1 suitable for gluing porcelain tiles on waterproofing. Grout using **CERPOXI** or **JUNTATEC**.



### 06 POSE DE LA CÉRAMIQUE

Nous installerons le grès avec le ciment colle **TECNOCOL FLEX** de classe C2 T S1, idéal pour coller le grès cérame sur l'imperméabilisation. Nous jointerons avec **CERPOXI** ou **JUNTATEC**.



SISTEMA SYSTEM SYSTÈME **S9 WIESBADEN**



SISTEMA SYSTEM SYSTÈME **S9 SPA**



**S9 WIESBADEN / S9 SPA**

Quando nos encontremos con una piscina con poco espacio de playa o busquemos una solución económica y fácil de colocar, los bloques S9 Wiesbaden o S9 Spa son los más idóneos.

- 1 Arranque del coronamiento antiguo y preparación del sistema de recogida de agua.
- 2 Colocación de los bloques del S9 con mortero aditivado con el látex **PRIMFIX**.
- 3 Anclaje de las esperas con resinas epoxídicas o tacho químico. Colocación de la junta hidroexpansiva **FUGA-STOP** y preparación del encofrado.
- 4 Relleno de hormigón del talón posterior con hormigón.
- 5 Impermeabilización del vaso y de los bloques S9 con **HIDROELASTIC** y de la canal desbordante con **HIDROFIX**.
- 6 Colocación de la cerámica con **TECNOCOL FLEX** (C2 T S1) y rejuntado con **CERPOXI** o **JUNTATEC**.

When we find a pool that has a small pool deck or we seek a cheap solution that is also easy to install, S9 Wiesbaden or S9 Spa blocks are the most suitable solutions.

- 1 Remove the old coping and prepare the water collection system.
- 2 Position the S9 blocks with mortar containing the latex additive **PRIMFIX**.
- 3 Anchor the reinforced bars with epoxy resins or chemical wadding. Place the **FUGA-STOP** concrete joint and prepare the formwork.
- 4 Fill the back gap with concrete.
- 5 Waterproof the tank and the S9 blocks with **HIDROELASTIC** and the overflow channel with **HIDROFIX**.
- 6 Attach the ceramic tile with **TECNOCOL FLEX** (C2 T S1). Grout with **JUNTATEC** or **CERPOXI**.

Les blocs S9 Wiesbaden ou S9 Spa sont les plus appropriés pour les piscines avec peu de plage ou lorsque nous recherchons une solution économique et facile à installer.

- 1 Retrait de l'ancien couronnement et préparation du système de collecte de l'eau.
- 2 Installation des blocs S9 avec du mortier enrichi en latex **PRIMFIX**.
- 3 Fixation des fers d'attente avec des résines époxydiques, ou cheville chimique. Installation du joint hydro-expansif **FUGA-STOP** et préparation du coffrage.
- 4 Remplissage du talon arrière avec du béton.
- 5 Imperméabilisation du bassin et des blocs S9 avec de l'**HIDROELASTIC**, et du canal de débordement avec de l'**HIDROFIX**.
- 6 Pose de la céramique avec du **TECNOCOL FLEX** (C2 T S1). Pour le scellement de joints, nous utiliserons le **JUNTATEC** or **CERPOXI**.

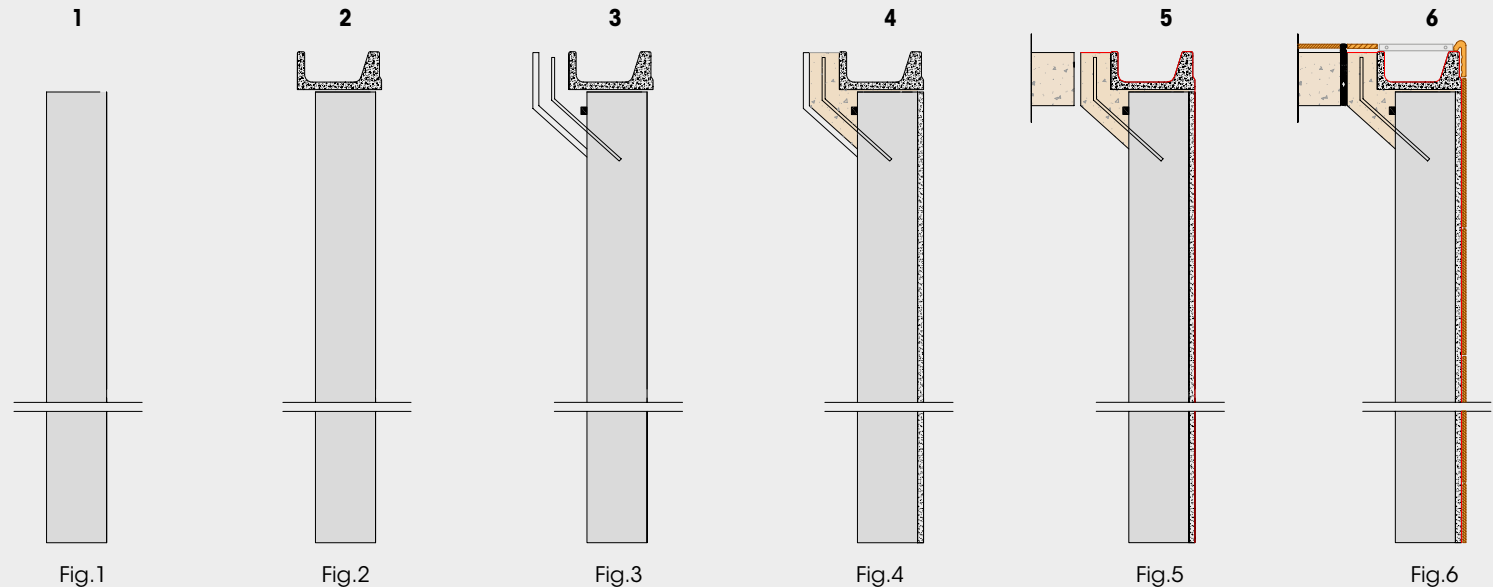





La seguridad en el pavimento es un factor que adquiere cada vez mayor importancia. La necesidad de evitar resbalones y caídas es imperativa, en especial en los lugares donde el pavimento puede estar mojado (en exteriores, piscinas, etc.) o pueda haber grasas u otros elementos que faciliten el resbalamiento (cocinas industriales).

Flooring safety is a factor that is becoming increasingly important. The need to avoid slips and falls is imperative, especially in places where the floor might be wet (outdoors, swimming pools, etc.) or covered in spill oils or other slippery elements (industrial kitchens).

La sécurité du revêtement est un facteur auquel on accorde de plus en plus d'importance. Le besoin d'éviter les glissades et les chutes est capital, en particulier dans les lieux où le revêtement peut être mouillé (en extérieur, dans les piscines, etc.) ou encore là où on peut trouver des graisses ou d'autres éléments provoquant des glissades (cuisines industrielles).



## DIN 51130

NORMA PARA PIE CALZADO  
NORM FOR SHOE TRAFFIC AREAS  
NORME PIEDS CHAUSÉ

	<b>R9</b>	<b>3° - 10°</b>
	<b>R10</b>	<b>&gt; 10° - 19°</b>
	<b>R11</b>	<b>&gt; 19° - 27°</b>
	<b>R12</b>	<b>&gt; 27° - 35°</b>

## DIN 51097

NORMA PARA PIE DESCALZO  
STANDARD FOR BARE FEET  
NORME PIEDS NUS

	<b>CLASE A</b>	<b>CLASS A</b>	<b>CLASSE A</b>	<b>≥12°</b>
	<b>CLASE B</b>	<b>CLASS B</b>	<b>CLASSE B</b>	<b>≥18°</b>
	<b>CLASE C</b>	<b>CLASS C</b>	<b>CLASSE C</b>	<b>≥24°</b>

### NORMA DIN

Los métodos de ensayo alemanes están pensados para pavimentos donde existe el riesgo de presencia de sustancias que favorecen el resbalamiento tanto con tránsito calzado (DIN 51130) como con tránsito descalzo (DIN 51097).

#### NORMA PARA PIE CALZADO

Este ensayo se realiza en un dispositivo en el que la persona que efectúa la prueba camina sobre un plano inclinado de ángulo variable con pie calzado de suela normalizada. La superficie está impregnada de aceite. El ángulo del plano inclinado que todavía permite caminar con seguridad sin deslizarse, es la medida del ensayo.

#### NORMA PARA PIE DESCALZO

El ensayo se realiza en un dispositivo en el que la persona que efectúa el ensayo camina descalzo sobre un plano inclinado de pendiente variable. La superficie está revestida con las baldosas a ensayar y está continuamente impregnada de una solución jabonosa. El ángulo del plano inclinado que todavía permite estar de pie con seguridad sin deslizarse es la medida del ensayo.

### DIN STANDARD

These German test methods are intended for floorings that present a risk of being covered in slippery substances, both for people wearing footwear (DIN 51130) or who are barefoot (DIN 51097).

#### STANDARD FOR FOOTWEAR

This test is performed on a device in which the person carrying out the test walks on an inclined slope which varies in angle, wearing footwear with standardised soles. The surface is covered with oil. The test seeks to find the angle of inclination of the slope with which they can still walk safely without slipping.

#### STANDARD FOR BARE FEET

This test is performed on a device in which the person carrying out the test walks on an inclined slope which varies in angle. The surface is covered with the tiles to be tested and is continually covered with a soap solution. The test seeks to find the angle of inclination of the slope with which they can still walk safely without slipping.

### NORME DIN

Les méthodes d'essai allemandes sont conçues pour des revêtements où il existe un risque de présence de substances favorisant la glissade aussi bien chaussé (DIN 51130) que pieds nus (DIN 51097).



#### NORME POUR PIED CHAUSÉ (PC)

Cet essai a lieu dans un dispositif dans lequel la personne effectuant le test marche sur un plan incliné à angle variable, le pied chaussé d'une semelle mise aux normes. La surface est imprégnée d'huile. L'angle du plan incliné qui permet encore de marcher en toute sécurité sans glisser indique la mesure de l'essai.

#### NORME POUR PIEDS NUS (PN)

L'essai a lieu dans un dispositif dans lequel la personne effectuant le test marche pieds nus sur un plan incliné dont la pente est variable. La surface est revêtue des dalles à tester et est continuellement imprégnée d'une solution savonneuse. L'angle du plan incliné qui permet de rester debout en toute sécurité sans glisser indique la mesure de l'essai.

## UNE - ENV 12633

	Rd < 15	CLASE 0	CLASS 0	CLASSE 0
	15 < Rd < 35	CLASE 1	CLASS 1	CLASSE 1
	35 < Rd < 45	CLASE 2	CLASS 2	CLASSE 2
	Rd > 45	CLASE 3	CLASS 3	CLASSE 3

## MÉTODO DEL PÉNDULO

El ensayo consiste en hacer oscilar un péndulo de fricción con un patín de goma en su extremo sobre la superficie a ensayar. El patín roza la superficie a lo largo de una distancia determinada (125 mm). En función de la textura de la superficie el péndulo se frena en mayor o menor medida. La disminución del recorrido del patín leída sobre una escala calibrada es el resultado del ensayo.

## PENDULUM METHOD

The test involves swinging a friction pendulum with a rubber skate on the end over the surface to be tested. The skate skims the surface along a determined distance (125 mm). Depending on the surface texture, the pendulum brakes to a greater or lesser degree. The test result indicates how much the skate's speed decreased, as measured on a calibrated scale.

## MÉTHODE DU PENDULE

Le test consiste à faire osciller un pendule de frottement présentant à son extrémité un patin en caoutchouc sur la surface à tester. Le patin frôle la surface tout au long d'une distance déterminée (125 mm). En fonction de la texture de la surface, le pendule ralentit plus ou moins. La diminution du parcours du patin sur une échelle de mesure constitue le résultat du test.

## ANSI A-137.1:2012

## MÉTODO DEL DINAMÓMETRO

El ensayo consiste en determinar la fuerza mínima, tangencial a la superficie, necesaria para iniciar el movimiento sobre la superficie a ensayar de un deslizador normalizado. Se realiza sobre la superficie seca y mojada. El resultado se expresa como coeficiente de fricción dinámico.

## DYNAMOMETER METHOD

The test consists in determining the minimum force required (tangential to the surface) to initiate the movement of a standard slider over the surface to be tested. The test is performed on dry and wet surfaces. The result is expressed as a coefficient of kinetic friction.

## MÉTHODE DU DYNAMOMÈTRE

L'essai consiste à déterminer la force minimale, la force tangentielle à la surface, nécessaire pour débiter le mouvement sur la surface de test d'un glisseur mis aux normes. L'essai doit être réalisé sur la surface sèche, puis mouillée. Le résultat est exprimé en tant que coefficient de frottement dynamique.







## PAVIMENTO INTERIOR

En el interior, aunque los requerimientos de antideslizamiento son menores, también se tienen que tener en cuenta, especialmente en las zonas húmedas como los baños o las cocinas, donde pueden derramarse grasa o aceites. No deben descartarse, por otra parte, las posibilidades de resbalar cuando se accede al interior con los zapatos mojados o el pavimento interior está recién lavado.

## INTERIOR FLOORING

Although anti-slip requirements are less stringent indoors, they should also be taken into account, especially in wet areas such as bathrooms or kitchens, where grease or oil might have been spilled. On the other hand, we should also not forget the chances of slipping when walking indoors with wet shoes or when the inside floor is freshly washed.

## REVÊTEMENT INTÉRIEUR

Bien que les exigences en matière de surfaces antidérapantes soient moindres en intérieur, il faut également y faire attention. En particulier dans les zones humides comme les salles de bain ou les cuisines, où peuvent se répandre de la graisse ou des huiles. Il ne faut pas non plus négliger les possibilités de glisser lorsqu'on y entre avec des chaussures mouillées ou si le revêtement intérieur vient d'être nettoyé.

### USO PÚBLICO PUBLIC USE USAGE PUBLIC

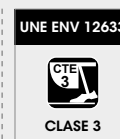
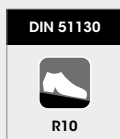

Vestuarios  
Changing rooms  
Vestiaires

Cocinas / Escaleras / Pendientes > 6 %  
Kitchen / Stairs / Slopes > 6 %  
Cuisines / Escaliers / Pentes > 6 %

Otras  
Others  
Otras

### USO PRIVADO PRIVATE USE USAGE PRIVÉ



## TERRAZAS

Las terrazas están expuestas a las inclemencias meteorológicas. La lluvia, la nieve, el hielo o la escarcha pueden aumentar el peligro de resbalones o caídas. Esto tiene que definir las características del material que se utilice. Es muy importante que cumpla los siguientes requerimientos mínimos: R10 (DIN 51130) y Clase 3 (UNE ENV 12633). Es esencial que la textura de la superficie, además de sus propiedades antideslizantes, sea fácil de limpiar y mantener. Los acabados Anti-slip y Abujardado cumplen estos dos requisitos.

## TERRACES

Terraces are exposed to the elements. Rain, snow, ice or frost may increase the danger of slipping or falling. This must define the characteristics of the material to be used. It is very important that the following minimum requirements are met: R10 (DIN 51130) and Class 3 (UNE ENV 12633). It is also essential that the surface texture, in addition to its anti-slip properties, should be easy to clean and to keep clean. Anti-slip and bush-hammered finishes meet these two requirements.

## TERRASSES

Les terrasses sont exposées aux rigueurs du climat. La pluie, la neige, le gel ou le givre peuvent accroître le risque de glissades ou de chutes. Ces éléments vont déterminer les caractéristiques du matériau à utiliser. Il est essentiel que ce matériau réponde aux exigences de base suivantes: R10 (DIN 51130) et Classe 3 (UNE ENV 12633). De plus, il est essentiel que la texture en surface, en plus de présenter des propriétés antidérapantes, soit facile à nettoyer et à maintenir propre. Les finitions Anti-slip et Bouchardée répondent à ces deux exigences.





## PLAYAS

En la zona de playa es esencial disponer de un material antideslizante especial para pie descalzo. Es de máxima importancia lograr un entorno seguro evitando en lo posible caídas y resbalones. Además de la clasificación 3 según UNE ENV 12633 del CTE proponemos que también cumpla la normativa DIN 51097 con una clase C.

El acabado **Pastilla** es un antideslizante de superficie texturada especial para zonas donde se **transita descalzo**. Garantiza un alto grado de antideslizamiento en zonas completamente mojadas y con el usuario en plena carrera. Además de provocar un efecto de agarre en el pie desnudo, evita, al canalizar el agua, el temido efecto "aquaplaning".





Acabado Pastilla  
Pastilla finish  
Finition Pastilla

## POOL DECKS

It is essential to have a special anti-slip material for bare feet in the pool deck area. It is of utmost importance to achieve a safe area, avoiding possible slips and falls. In addition to classification 3 according to ENV 12633 of CTE, we propose that the DIN 51097 is also met with a class C.

The **Pastilla** finish is a special textured surface for areas where people **walk barefoot**. They guarantee a high level of anti-slip in completely wet areas, even when the user runs. In addition to gripping bare feet, they prevent the dreaded "aquaplaning" effect as they channel the water.

UNE ENV 12633	DIN 51097	XP-P-05-010
		
CLASE 3	CLASS C	PN 24

## PLAGES

Il est essentiel de disposer, dans la zone de plage, d'un matériau antidérapant spécial pieds nus. Il est d'une importance capitale d'obtenir un environnement sûr, en évitant dans la mesure du possible les chutes et les glissades. En plus de la classification 3 conforme à l'UNE ENV 12633 du CTE, nous faisons en sorte que le matériau respecte également la norme DIN 51097 de classe C.

Le finition **Pastilla** est une finition antidérapante à la surface texturée spécifiques pour les zones où **l'on marche pieds nus**. Ces finitions garantissent un très bon niveau antidérapant dans des zones complètement mouillées et un usager en pleine course. En plus de provoquer un effet d'adhérence sur le pied nu, ces finitions évitent l'effet « aquaplaning » tant redouté, en canalisant l'eau.



## VESTUARIOS

Los vestuarios son la zona más sensible de la piscina, ya que se transita tanto con pie calzado como descalzo y se requiere máxima higiene y limpieza. Por tanto necesitamos un pavimento que cumpla con las necesidades de antideslizamiento tanto de pie calzado como descalzo.

**Nota:** Los acabados ANTI-SLIP y ABUJARDADO cumplen con las normativas de antideslizamiento requeridas. Consultar la ficha técnica de cada serie.

## CHANGING ROOMS

Changing rooms are a pool's most sensitive area, as people here walk both barefoot and with footwear, whereby maximum hygiene and cleanliness is required. We need the flooring to meet the anti-slip requirements for both people walking with footwear and barefoot.

**Note:** The ANTI-SLIP and ABUJARDADO (bush-hammered) finishes meet the required anti-slip regulations. Consult the data sheet for each series.

## VESTIAIRES

Les vestiaires sont l'endroit le plus sensible de la piscine, puisqu'on y marche aussi bien pieds chaussés que pieds nus et cette zone requiert une hygiène et une propreté optimales. Par conséquent, nous avons besoin d'un revêtement répondant aux conditions d'antiglissance aussi bien pieds chaussé que pieds nus.

**Remarque:** Les finitions ANTI-SLIP, et ABUJARDADO (bouchardée) remplissent les conditions antidérapantes exigées. Consulter la fiche technique de chaque série.

ZONA SECA DRY AREA ZONE SÈCHE

UNE ENV 12633	DIN 51097	XP-P-05-010	DIN 51130	XP-P-05-010
				
CLASE 2 o 3	MÍNIMO CLASE B	PN 18	MÍNIMO R10	PC 20

SEGÚN PENDIENTE  
DEPENDING ON THE GRADIENT  
SELON L'INCLINAISON

DUCHAS Y ZONA HÚMEDA SHOWERS AND WET AREA DOUCHES ET ZONE HUMIDE

UNE ENV 12633	DIN 51097	XP-P-05-010
		
CLASE 2 o 3	MÍNIMO CLASE C	PN 24

SEGÚN PENDIENTE  
DEPENDING ON THE GRADIENT  
SELON L'INCLINAISON





### LIMPIEZA "DE CHOQUE" DE FIN DE OBRA

Durante la ejecución de la obra el pavimento acumula suciedad debido a sus propiedades antideslizantes. Por este motivo es imprescindible realizar una "limpieza de choque" al finalizar la obra.

#### PASO A PASO

- 1 Durante la instalación eliminamos todos los restos de material de agarre y rejuntado. Es imprescindible limpiarlos "al momento" con una esponja húmeda y no permitir que se sequen. La textura rugosa del acabado antideslizante dificultaría notablemente su posterior eliminación en seco.
- 2 Barremos toda la superficie y recogemos los restos de obra para evitar la formación de "barrillo" en futuras acciones de limpieza. Comprobamos que las juntas se han endurecido totalmente.
- 3 Nos aseguramos que no quedan restos secos de material de rejuntado o agarre. En algunos casos es inapreciable porque el color del rejuntado es muy similar al de la plaqueta cerámica.

Si observamos que todavía quedan restos de obra, y las juntas se han endurecido del todo, seguiremos las siguientes pautas:

Preparamos una dilución de **GRESNET** en agua. Empezaremos con una concentración muy baja. Aplicamos la dilución sobre una pequeña zona utilizando un cepillo de púas duras. En húmedo y sin esperar a que se seque aclaramos con abundante agua para eliminar todos los restos.

Para restos de compuestos epoxídicos: aplicamos el decapante **EPOXI CLEANER**. Procedemos a una eliminación mecánica de la suciedad pasada una hora como mínimo. Finalmente enjuagamos con abundante agua limpia.

Es importante tener la precaución de no atacar la junta, ya que en este caso el material de la junta ensuciaría aún más la superficie de las baldosas.

### CRASH CLEANING AFTER FINISHING THE WORK

While carrying out the work, the flooring becomes dirty due to its anti-slip properties. It is therefore essential to perform a "crash cleaning" after finishing the work.

#### STEP BY STEP

- 1 During the installation, we should remove all traces of adhesive material and grouting. It is imperative to clean them instantly with a damp sponge and not allow them to dry. The rough texture of the anti-slip finish will make it notably more difficult to remove once dry.
- 2 We should sweep the entire surface and collect all of the construction debris to prevent the formation of "smears" during future cleanups. We should check that the joints have hardened completely.
- 3 We should ensure there are no traces of dry grout or fixing material. In some cases, this cannot be seen as the grouting colour is very similar to that of the ceramic tiles.

If we find that there are still remnants of work materials, and the joints have hardened completely, we should follow these guidelines:

Prepare the **GRESNET** dilution in water. We should start with a very low concentration. We should apply the dilution over a small area, using a hard bristle brush. Whilst wet and without waiting for it to dry, we should rinse with plenty of water to remove all traces.

For remnants made from epoxy compounds: we should apply the **EPOXI CLEANER** stripper. We should proceed to mechanically remove the dirt after at least one hour has passed. Finally we rinse with plenty of clean water.

It is important to be careful not to attack the joint, as in this case the material from the joint would further dirty the surface of the tiles.

### NETTOYAGE « À FOND » EN FIN DE TRAVAUX

Au cours de l'exécution des travaux, le revêtement accumule de la saleté en raison de ses propriétés antidérapantes. Pour cette raison, il est indispensable de réaliser un « nettoyage à fond » à la fin des travaux.

#### ÉTAPE PAR ÉTAPE

- 1 Pendant l'installation, nous éliminons tous les restes du matériel de prise et de jointoiment. Il est indispensable de les nettoyer « sur le moment », avec une éponge humide et ne pas les laisser sécher. La texture rugueuse de la finition antidérapante rendrait bien plus dure une élimination postérieure à sec.
- 2 Nous balayons l'ensemble de la surface et nous ramassons les restes du chantier, pour éviter la formation de saletés lors des prochains nettoyages. Nous vérifions que les joints ont complètement durci.
- 3 Nous nous assurons qu'il n'y a plus aucun reste séché de matériel de jointoiment ou de prise. Dans certains cas, il est impossible de s'en assurer car la couleur du jointoiment est très proche de celle de la plaquette céramique.

Si nous observons qu'il y a encore des restes des travaux et que les joints se sont totalement durcis, nous suivrons les règles suivantes:

Nous préparons une dilution de **GRESNET** dans de l'eau. Nous commencerons avec une concentration très faible. Nous appliquons la dilution sur une petite zone, en utilisant une brosse dure. Rincer abondamment à l'eau lorsque la surface est encore humide et avant qu'elle ne sèche, pour éliminer tous les restes.

Dans le cas de restes comprenant des composés époxidiques: appliquer le décapant **EPOXI CLEANER**. Nous procédons à une élimination systématique de la saleté au bout d'une heure minimum. Pour finir, nous rinçons abondamment à l'eau claire.

Il est important d'agir avec précaution et de ne pas abîmer le joint, car dans ce cas le matériau composant le joint salirait encore davantage les dalles.



## MANTENIMIENTO Y LIMPIEZA DIARIA

Para eliminar la suciedad diaria normal, la mejor solución es utilizar un buen producto de limpieza combinado con una correcta acción.

## NUESTROS CONSEJOS

### 1 Limpieza cotidiana

Es suficiente utilizar agua limpia y el detergente de base alcalina **FIX-SABÓ**. Debe evitarse el uso de detergentes que dejan una capa superficial de cera o grasa, puesto que potenciarían la adherencia de la suciedad. Además, podrían influir negativamente en las propiedades antideslizantes del pavimento.

### 2 Manchas rebeldes y áreas conflictivas

Recomendamos el uso de equipos de limpieza de alta presión o máquinas limpiadoras con cepillos cilíndricos o rotativos. También se puede utilizar agua caliente y limpiar más una acción de cepillado enérgico.

### 3 Agua limpia siempre

Para un resultado óptimo es recomendable cambiar el agua de lavado cada 15 m<sup>2</sup> de suelo limpiado, aproximadamente. Si aprovechamos más el agua, la suciedad en suspensión se depositará sobre la plaqueta a limpiar.

### 4 Alcalinidad del agua

En las zonas geográficas donde el agua tiene un alto grado de dureza recomendamos la instalación de un descalcificador. Si no disponemos de uno, y para evitar que se deposite la cal, recogeremos el agua inmediatamente después de limpiar.

## MAINTENANCE AND DAILY CLEANING

To remove normal daily dirt, the best solution is to use a good cleaning product combined with correct action.

## OUR ADVICE

### 1 Daily cleaning

Simply use clean water and the alkaline-based detergent **FIX-SABÓ**. Avoid the use of detergents that leave a surface layer of wax or grease, since that would enhance the adherence of dirt. They could also adversely affect the anti-slip resistance of the floor.

### 2 Stubborn spots and conflictive areas

We recommend using high pressure cleaning equipment or cleaning machines with rotating cylindrical brushes. Hot water and brushing aggressively are also recommendable.

### 3 Always with clean water

For the best results, we recommend changing the cleaning water approximately every 15 m<sup>2</sup> of floor. If we continue using the water, the dirt in suspension will be deposited onto the following the tiles you clean.

### 4 Water alkalinity

In geographical areas where the water is hard, we recommend installing a water softener. If we do not have one, to prevent lime deposits collect the water immediately after cleaning.

## MAINTENANCE ET NETTOYAGE QUOTIDIEN

Pour éliminer la saleté quotidienne courante, la meilleure solution est d'utiliser un bon produit de nettoyage associé à une action correcte.

## NOS CONSEILS

### 1 Nettoyage quotidien

Il suffit d'utiliser de l'eau claire et le détergent alcalin **FIX-SABÓ**. Il faut éviter d'utiliser des détergents laissant une couche superficielle de cire ou de graisse, puisque cela renforcerait l'adhérence de la saleté. De plus, ils pourraient avoir une influence négative sur les propriétés antidérapantes du revêtement.

### 2 Taches tenaces et zones difficiles

Nous recommandons l'utilisation de machines de nettoyage à haute pression ou des équipements disposant brosses cylindriques ou rotatives. Il est également possible d'utiliser de l'eau chaude et claire couplée avec un brossage énergique.

### 3 N'utiliser que de l'eau claire

Pour un résultat optimal, il est recommandé de changer l'eau de nettoyage environ tous les 15 m<sup>2</sup> de sol nettoyé. Si nous gardons la même eau trop longtemps, la saleté en suspension viendra se déposer sur le carrelage à nettoyer.

### 4 Alcalinité de l'eau

Dans les zones géographiques où l'eau est très dure, nous recommandons l'installation d'un décalcifiant. Dans le cas où nous ne disposerions pas de décalcifiant et pour éviter le dépôt de calcaire, nous récolterons l'eau immédiatement après le nettoyage.



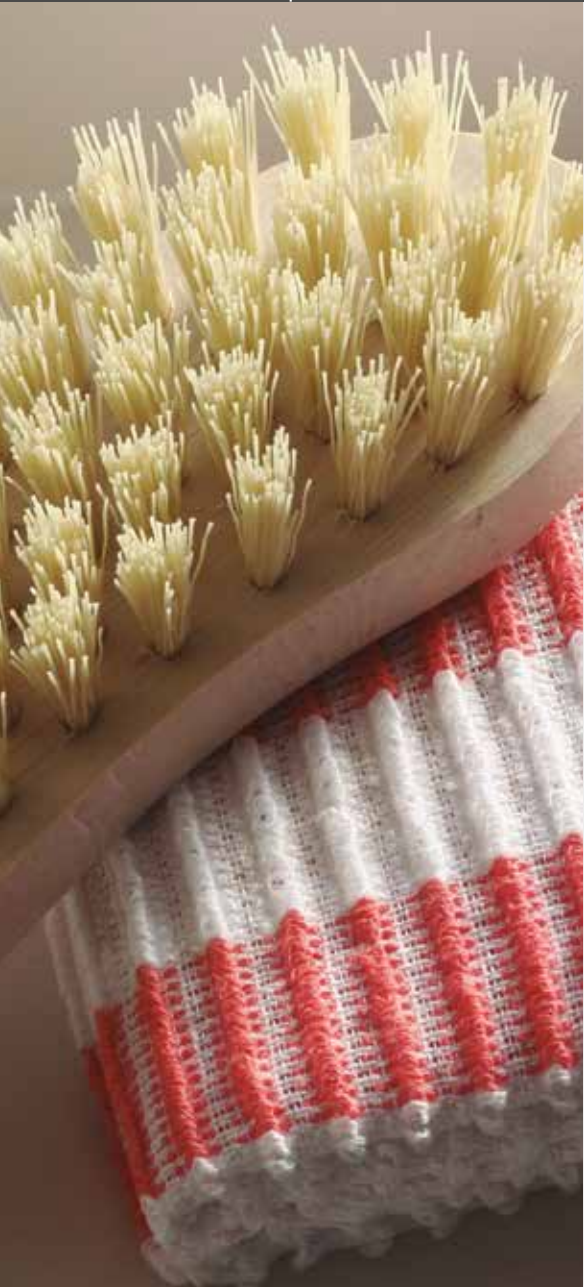

Los pavimentos cerámicos de Rosa Gres son resistentes a las manchas según la norma ISO 10545-14. Los ensayos indican que como mínimo corresponden a la clase 4, en la que es fácil hacer desaparecer una mancha.

## CÓMO TRATAR LAS MANCHAS

### Manchas y suelos antideslizantes

Los pavimentos antideslizantes presentan superficies rugosas y merecen una atención especial. Cuando un elemento que mancha penetra en la rugosidad superficial de la pieza debe ser eliminado aplicando la técnica adecuada según su naturaleza. En primer lugar, procederemos a disolver la mancha. Posteriormente, la eliminaremos utilizando cualquier medio mecánico.

### Manchas difíciles

Son especialmente problemáticas las manchas producidas por partículas de carbono (materiales de rejuntado de color negro, pinturas negras, lápices de grafito y similares). Este tipo de manchas no pueden ser disueltas ni atacadas. Sólo podremos eliminarlas por medios mecánicos.

### Identificar la naturaleza de la mancha

Es muy importante identificar qué elemento ha causado una mancha. Eliminaremos la mancha si utilizamos el producto adecuado. No es aconsejable utilizar productos de forma aleatoria. Es muy útil realizar una prueba de limpieza en una zona pequeña para contrastar su acción. Después de utilizar un producto de limpieza y antes de emplear otro diferente debemos asegurarnos de que no quedan restos del primero.

### Atención

Cuando utilicemos un producto químico debemos seguir las instrucciones incluidas en su hoja de seguridad o las instrucciones de uso que facilita el fabricante. Recomendamos, en todos los casos, usar guantes y gafas protectoras; además de ventilar en lo posible la zona a tratar.

Rosa Gres ceramic tiles are resistant to stains in accordance with the ISO 10545-14 standards. Tests indicate that they correspond at least to class 4, which means stains can be easily removed.

## HOW TO TREAT STAINS

### Stains and anti-slip floors

Anti-slip floors have rough surfaces and need special attention when a staining element penetrates their surface roughness. It must be removed by using the appropriate technique for what it is made of. First, we should try to dissolve the stain. Later, we should remove it by any mechanical means necessary.

### Difficult stains

Stains that are especially difficult are those caused by carbon particles (black-colored grouts, black paints, graphite pencils and the like). This type of stain cannot be dissolved or attacked. It can only be removed by mechanical means.

### Identifying the nature of the stain

It is very important to identify which element has caused a stain. The stain can be removed if we use the right product; it is not advisable to use products at random. It is very useful to perform a cleaning test on a small area to check its action. After using one cleaning product and before using another, we must ensure that all traces of the former have been removed.

### Attention

When we use a chemical product, we should follow the instructions included in the safety sheet or operating instructions provided by the manufacturer. We recommend wearing gloves and goggles in all cases, and to ventilate the area being treated if possible.

Les revêtements céramiques de Rosa Gres résistent aux taches conformément à la norme ISO 10545-14. Les essais précisent que les revêtements doivent être au minimum de classe 4, pour faire disparaître une tache facilement.

## COMMENT TRAITER LES TACHES

### Tâches et sols antidérapants

Les revêtements antidérapants présentent des surfaces rugueuses et méritent une attention particulière. Lorsqu'un élément provoquant des taches pénètre la rugosité de la surface de la pièce, il doit être éliminé en appliquant la technique adaptée à ses caractéristiques. En premier lieu, nous procéderons à la dissolution de la tache. Ensuite, nous l'éliminerons en utilisant un moyen mécanique.

### Tâches difficiles

Les taches qui posent particulièrement problème sont celles causées par des particules de carbone (matériaux de jointoiement de couleur noire, peintures noires, crayons de bois et matériaux similaires). Ce type de taches ne peut être ni dissous ni attaqué. Nous pourrions uniquement les éliminer par des moyens mécaniques.

### Identifier la nature de la tache

Il est très important d'identifier l'élément ayant provoqué la tache. Nous éliminerons la tache en utilisant le produit adapté. Il est déconseillé d'utiliser des produits de façon aléatoire. Il est très efficace de réaliser un test de propreté sur une petite surface pour évaluer son action par comparaison. Après avoir utilisé un produit nettoyant et avant d'en employer un différent, nous devons nous assurer qu'il ne reste plus aucune trace du premier produit.

### Attention

En cas d'utilisation d'un produit chimique, il faut suivre les instructions données sur la fiche de sécurité ou bien les instructions d'utilisation fournies par le fabricant. Nous recommandons dans tous les cas l'utilisation de gants et de lunettes de protection, ainsi que la ventilation, dans la mesure du possible, de la surface à traiter.

TABLA DE LIMPIEZA DE MANCHAS / STAIN CLEANING CHART / TABLEAU DE NETTOYAGE DES TACHES

TIPO DE MANCHA TYPE OF STAIN TYPE DE TACHE	AGENTE DE LIMPIEZA / CLEANING AGENT / AGENT NETTOYANT		
	ACCIÓN SUAVE LIGHT ACTION ACTION DOUCE	ACCIÓN ENERGICA VIGOROUS ACTION ACTION ÉNERGIQUE	ACCIÓN MUY ENERGICA HIGHLY VIGOROUS ACTION ACTION TRÈS ÉNERGIQUE
Cemento y residuos calcáreos Cement and calcareous residues Ciment et résidus calcaires	Detergente de base ácida (viakal) Acid-base detergent (antiscalant) Détergent à base acide (viakal)	Gresnet diluido o Ácidos orgánicos diluidos (vinagre) Diluted organic acids (vinegar) diluted Gresnet Gresnet dilué ou acides organiques dilués (vinaigre)	Ácido clorhídrico o Gresnet Hydrochloric acid or Gresnet Acide chlorhydrique ou Gresnet
Depósitos de óxidos y manchas de herrumbre Oxide deposits and rust stains Dépôts et taches de rouille	Detergente de base ácida Acid-base detergent Détergent à base acide	Ácido fosfórico o Gresnet Phosphoric acid or Gresnet Acide phosphorique ou Gresnet	
Aceites vegetales y animales Vegetable and animal fat Huiles végétales et animales	Detergente de base alcalina (amoniacal) Alkaline-based detergent (ammonia) Détergent à base alcaline (ammoniac)	Alcohol etílico Ethyl alcohol Alcool éthylique	
Grasas vegetales y animales Vegetable and animal fat Graisses végétales et animales	Detergente de base alcalina (amoniacal) Alkaline-based detergent (ammonia) Détergent à base alcaline (ammoniac)	Bicarbonato y agua Bicarbonate and water Bicarbonate et eau	Tricloroetileno o sosa cáustica Trichloroethylene or caustic soda Trichloréthylène ou soude caustique
Alquitrán o betún Tar or bitumen Goudron ou bitume	Detergente de base alcalina (lejía) Alkaline-based detergent (bleach) Détergent à base alcaline (eau de javel)	Alcohol o acetona Alcohol or acetone Alcool ou acétone	Tricloroetileno Trichloroethylene Trichloréthylène
Restos de pintura Paint remnants Restes de peinture	Disolvente específico (aguarrás) Specific dissolvent (turpentine) Dissolvant spécifique (essence de térébenthine)	Acetona Acetone Acétone	
Restos de goma o caucho Remnants of rubber or latex Restes de caoutchouc	Disolvente específico (tricloroetileno) Specific dissolvent (trichloroethylene) Dissolvant spécifique (trichloréthylène)	Disolventes orgánicos Organic solvents Dissolvants organiques	
Cerveza o vino Beer or wine Bière ou vin	Detergente con base alcalina (lejía) Alkaline-based detergent (bleach) Détergent à base alcaline (eau de javel)	Alcohol o acetona Alcohol or acetone Alcool ou acétone	Sosa cáustica o carbonato potásico Caustic soda or potassium bicarbonate Soude caustique ou carbonate de potassium
Compuestos basados en yodo y cromo Iodine and chromium-based compounds Composés à base d'iode et de chrome	Detergente con base ácida y posteriormente agua oxigenada Acid-based detergent followed hydrogen peroxide Détergent à base acide et ultérieurement eau oxygénée	Lejía, Amoníaco Bleach, ammonia Eau de javel, Ammoniac	Sosa cáustica o carbonato potásico Caustic soda or potassium bicarbonate Soude caustique ou carbonate de potassium
Sangre Blood Sang	Agua oxigenada Hydrogen peroxide Eau oxygénée	Hipoclorito sódico (lejía) Sodium hypochlorite (bleach) Hypochlorite de sodium (eau de javel)	
Café, té, zumos, Coca-cola, helados Coffee, tea, juice, Coca-Cola, ice cream Café, thé, jus, Coca-Cola, glaces	Detergente de base ácida (viakal) Alkaline-based detergent (ammonia) Détergent à base acide (viakal)	Alcohol o acetona, Bicarbonato de sodio Alcohol or acetone, sodium bicarbonate Alcool ou acétone, Bicarbonate de sodium	Sosa cáustica, hidróxido potásico Caustic soda, potassium hydroxide Soude caustique, hydroxyde de potassium
Tinta o mercurina Dye or merbromin Encre ou mercurochrome	Detergente de base ácida (viakal) Alkaline-based detergent (ammonia) Détergent à base acide (viakal)	Alcohol o acetona Alcohol or acetone Alcool ou acétone	



**Piezas base:**

Grupo B1a gres porcelánico prensado

**Base pieces:**

Grupo B1a pressed porcelain tiles

**Pièce de base:**

Grupo B1a grès cerame pressé

**Piezas especiales:**

Grupo A1a gres porcelánico extrusionado

**Trim pieces:**

Grupo A1a extruded porcelain tiles

**Pièces spéciales:**

Grupo A1a grès cerame étiré

**Junta de colocación mínima (Pieza base)**

Se precisa una junta mínima de colocación de 2 mm. En los formatos de 48,8 x 48,8 cm y 48,8 x 79,2 cm, se recomienda una junta mínima de 3 mm. Cuando se quiera modular la pieza base con la pieza especial o entre diferentes formatos de piezas base, la junta deberá ser de 6 mm (excepto en las series Projecta, Lovely y el formato 48,8 x 79,2 cm).

**Minimum joint (Field tiles)**

A 2 mm joint is needed. A minimum joint of 3 mm is recommended for the following formats: 48.8 x 48.8 cm and 48.8 x 79.2 cm. When it's necessary to modulate field tiles with trim pieces, the joint should be 6 mm (except for Projecta, Lovely and 48.8 x 79.2 cm format).

**Joint de pose minimum (Pièces base)**

Il est nécessaire d'utiliser un joint de pose de 2 mm. Pour les formats de 48,8 x 48,8 y 48,8 x 79,2 cm le joint doit être d'au moins 3 mm. Si vous souhaitez moduler les carreaux et les pièces spéciales, le joint devra être de 6 mm (sauf dans les séries Projecta, Lovely et le format 48,8 x 79,2 cm).

\* **Biostop (cerámica y junta) garantiza la norma JIS Z 2801: 2000 Eficacia antibacteriana.**

\* **Biostop (tiles and grout) complies with the JIS Z 280: 2000 Antimicrobial efficiency regulation.**

\* **Biostop (carreaux et joints) est conforme aux normes JIS Z 280: 2000 Efficacité antimicrobienne.**

**NORMATIVA DE ENSAYO  
TESTING REGULATIONS  
NORME D'ESSAI**

**NORMATIVA  
REGULATION  
RÉGLEMENTATION  
EN 14411**

**Aqua / Serena  
Bohème / Mistery / Tao  
Vintage / Lovely  
Garden / Natural 2.0  
Bio-white (Biostop)**

**Indugres  
Biobeige (Biostop)  
Projecta**

**Mosaic**



**CARACTERÍSTICAS DIMENSIONALES / DIMENSIONS AND SURFACE QUALITY / DIMENSIONS ET ASPECT DE LA SURFACE**

 <b>ISO 10545-2</b>	Características dimensionales Dimensions and surface quality Dimensions et aspect de la surface	Exigida Required Exigée	Garantizada Guaranteed Garantie	Garantizada Guaranteed Garantie	Garantizada Guaranteed Garantie
--	---	-------------------------------	---------------------------------------	---------------------------------------	---------------------------------------

**PROPIEDADES FÍSICAS / PHYSICAL PROPERTIES / PROPRÉTÉS PHYSIQUES**



 <b>ISO 10545-3</b>	Absorción de agua Water absorption Absorption d'eau	Grupo A1a E < 0,5 %	Grupo B1a E < 0,5 %	E < 0,5 %	E < 0,5 %	E < 0,5 %
 <b>ISO 10545-4</b>	Resistencia a la flexión Modulus of rupture Résistance à la flexion	Grupo A1a > 28 N/mm <sup>2</sup>	Grupo A1a > 35 N/mm <sup>2</sup>	> 40 N/mm <sup>2</sup>	> 40 N/mm <sup>2</sup>	-
 <b>ISO 10545-6</b>	Resistencia a la abrasión profunda Resistance to deep abrasion Résistance à l'abrasion	< 175 mm <sup>3</sup>		-	< 175 mm <sup>3</sup>	-
 <b>ISO 10545-9</b>	Resistencia al choque térmico Thermal shock resistance Résistance au choc thermique	Exigida Required Exigée	Garantizada Guaranteed Garantie	Garantizada Guaranteed Garantie	Garantizada Guaranteed Garantie	-
 <b>ISO 10545-12</b>	Resistencia a la helada Frost resistance Résistance au gel	Exigida Required Exigée	Garantizada Guaranteed Garantie	Garantizada Guaranteed Garantie	Garantizada Guaranteed Garantie	Garantizada Guaranteed Garantie

**PROPIEDADES QUÍMICAS / CHEMICAL PROPERTIES / PROPRÉTÉS CHIMIQUES**

 <b>ISO 10545-13</b>	Resistencia química (1) Chemical resistance (1) Résistance chimique (1)	Min. Clase B	GA GLA GHA	UA ULA UHA	GA GLA GHA
 <b>ISO 10545-14</b>	Resistencia a las manchas Stain resistance Résistance aux tâches	Min. Clase 3	Garantizada Guaranteed Garantie	Garantizada Guaranteed Garantie	Garantizada Guaranteed Garantie

(1) Excepto ácido fluorhídrico y sus compuestos / Except hydrofluoric acid and its components / À l'exception de l'acide fluorhydrique et de ses composés

## COEFICIENTES ANTIDESLIZAMIENTO / ANTI-SLIP COEFFICIENTS / COEFFICIENTS D'ANTI-GLISSEMENT

			 UNE ENV 12633			 DIN 51130 XP P-05-010				 DIN 51097 XP P-05-010		 ANSI A137.1	
			Clase 1	Clase 2	Clase 3	R9 / PC6	R10 / PC10	R11 / PC20	R12 / PC27	Clase B / PN18	Clase C / PN 24	> 0.42	
metro	<b>aqua</b>	pastilla anti-slip <small>Vaso / Tank / Bassin</small>			●						●		
	<b>indugres</b>	indubeige R9	●			●					●		
		indubeige R10		●			●				●		
		indu grey R10		●			●				●		
		indu tech R10		●			●				●		
		indubeige R11			●			●			●		
		indubeige R12			●				●			●	
		indu tech R12			●				●			●	
		indu grey R12			●				●			●	
	<b>biostop</b>	biobeige R10		●			●				●		●
		biobeige R11			●			●			●		
		biobeige R12			●				●			●	●
		biobeige pastilla			●							●	●
	<b>mosaic</b>	<b>mosaic</b>	anti-slip			●						●	
<b>project</b>	<b>proyecta</b>	liso	●			●						●	
		abujardado			●		●				●		●
i'perfect	<b>serena</b>	anti-slip			●		●				●	●	
		liso	●			●						●	
	<b>bohème</b>	anti-slip			●		●					●	●
		liso	●			●							●
	<b>mystery</b>	anti-slip			●		●					●	●
		liso	●			●							●
	<b>tao</b>	anti-slip			●		●					●	●
		liso	●			●							●
	<b>vintage</b>	anti-slip			●		●					●	●
		liso	●			●							●
<b>lovely</b>	anti-slip			●		●					●	●	
	liso	●			●							●	
<b>garden</b>	anti-slip			●		●					●	●	
<b>natural 2.0</b>	anti-slip			●		●				●			



**PROYECTO ZERO,  
NUESTRO COMPROMISO  
CON EL MEDIO AMBIENTE**

Rosa Gres es una empresa comprometida con la protección del medio ambiente. La fuerza de este compromiso nos llevó en 2010 a crear el Proyecto Zero. Se trata de un sistema de trabajo propio que integra todas las acciones que realizamos para favorecer el desarrollo sostenible.

El Proyecto Zero se estructura a través de una serie de programas específicos y se basa en los siguientes valores:

- Practicar una mejora continuada y transversal en todas las áreas de la empresa conscientes del futuro a corto y largo plazo. Las instalaciones de Rosa Gres en Vallmoll son consideradas IBE (Instalación de Baja Emisión).
- Producir de forma eficiente y controlada para reducir el consumo de recursos naturales.
- No generar residuos durante el proceso de producción: separar, reutilizar, valorizar.
- Diseñar cada producto siguiendo los principios del Eco Diseño.
- Prever y controlar el impacto medioambiental del producto Rosa Gres una vez acabado: su traslado desde la fábrica, su vida útil y su reciclaje final.

**PROJECT ZERO,  
OUR COMMITMENT  
TO THE ENVIRONMENT**

Rosa Gres is a company committed to protecting the environment. The strength of this commitment led us to create Project Zero in 2010. This is our own personalized work system which integrates all the actions we undertake to promote sustainable development.

Project Zero is structured via a series of specific programs and is based on the following values:

- To continuously improve all areas of the company in a transversal manner, being aware of both the short-term and long-term future. The Rosa Gres facilities in Vallmoll are considered IBE, which stands for Low Emission Facilities.
- To produce in an efficient and controlled manner, in order to reduce the consumption of natural resources.
- To not generate residues during the production process: separate, reuse and assess.
- To design each product in accordance with the principles of Ecodesign.
- To prevent and control the environmental impact of the finished Rosa Gres product: its transportation from the factory, useful life and final recycling.

**PROJET ZÉRO,  
NOTRE ENGAGEMENT  
ENVERS L'ENVIRONNEMENT**

Rosa Gres est une entreprise engagée dans la protection de l'environnement. La force de cet engagement nous a poussé à créer le Projet Zéro en 2010. Il s'agit d'un système de travail personnalisé qui intègre toutes les actions que nous réalisons pour favoriser le développement durable.

Le Projet Zéro se structure sur des programmes spécifiques et se base sur les valeurs suivantes:

- Améliorer de manière continue et transversale les différents domaines de l'entreprise, prenant conscience de l'avenir à court et long terme. Les installations Rosa Gres à Vallmoll sont des installations à faible émission.
- Produire de manière efficace et contrôlée pour réduire la consommation de ressources naturelles.
- Ne pas générer de résidus pendant le processus de production: séparer, réutiliser, valoriser.
- Concevoir chaque produit selon les principes de l'écoconception.
- Prévoir et contrôler l'impact environnemental du produit Rosa Gres fini: son transport depuis l'usine, sa durée de vie et le recyclage final.



**PROGRAMAS  
POYECTO ZERO****Zero Vertidos**

Reutilizamos el 100% del agua del proceso productivo

**Zero Residuos**

Segregamos y reciclamos el 100% de los residuos valorizables

**Reciclaje Non-Stop**

Procesamos todos los materiales del ciclo de producción para su reutilización

**Zero Emisiones**

Optimización mediante el control y gestión on-line de los recursos energéticos

**Sistemas Constructivos**

Diseñamos sistemas constructivos que minimizan el residuo en la obra, reducen el tiempo de ejecución y aseguran el resultado final

**PROJECT ZERO  
PROGRAMS****Zero Water Discharge**

We recycle 100% of the water used during the production process

**Zero Waste**

We separate and recycle 100% of our recoverable waste

**Non-Stop Recycling**

We process and reuse all materials involved in the production process

**Zero Emissions**

Optimization via online control and management of our energy resources

**Constructive Systems**

We design constructive systems that minimize residues during the construction process, reduce execution time and guarantee the final result

**PROGRAMMES  
PROJET ZÉRO****Zéro Eau Déversée**

Nous recyclons 100% de l'eau utilisée pendant la production

**Zéro Déchet**

Nous séparons et recyclons 100% des résidus valorisables

**Recyclage Non-Stop**

Nous utilisons tous les matériels du cycle de production en vue de les réutiliser

**Zéro Émission**

Optimisation par application informatique des ressources énergétiques

**Systèmes Constructifs**

Nous concevons des systèmes constructifs qui minimisent les résidus sur chantier, réduisent le temps d'exécution et assurent la qualité de résultat final

**CERTIFICACIONES  
MEDIOAMBIENTALES**

**Rosa Gres** formó parte del comité de desarrollo de la normativa DAPc®, la nueva Ecoetiqueta europea de tipo III que permite evaluar el impacto ambiental a lo largo del ciclo de vida del producto y su proceso de fabricación.

La utilización de productos cerámicos, sistemas de construcción y sistemas de colocación **Rosa Gres** aporta puntos LEED a los edificios.

**Rosa Gres** es miembro del GBCe desde junio de 2010. Marcel·lí Sugrañes, presidente de **Rosa Gres**, es vocal en representación del grupo de empresas de GBCe en España.

La materia prima utilizada para fabricar las rejillas de madera de las piscinas, proviene de zonas controladas donde se obtiene de forma sostenible y se favorece la regeneración forestal.

**ENVIRONMENTAL  
CERTIFICATES**

**Rosa Gres** was part of the development committee for the DAPc® standard, the new European type III Eco tag that enables the assessment of environmental impact throughout the life cycle of the product and its manufacturing process.

The use of ceramic products and the construction and placement systems at **Rosa Gres** provide buildings with LEED points.

**Rosa Gres** has been a member of the GBCe since June 2010. Marcel·lí Sugrañes, president of **Rosa Gres**, is the spokesperson for the group of GBCe companies in Spain.

The raw material used to manufacture the wooden grilles for our pools comes from managed sources, where it is harvested in a sustainable manner that aids forest regeneration.

**CERTIFICATIONS  
ENVIRONNEMENTALES**

**Rosa Gres** faisait partie du comité de développement de la norme DAPc®, le nouvel écolabel européen de type III qui permet d'évaluer l'impact environnemental tout au long du cycle de vie du produit et de sa fabrication.

L'utilisation de produits céramiques, de systèmes de construction et d'installation **Rosa Gres** apporte des points LEED aux bâtiments.

**Rosa Gres** est membre du GBCe depuis juin 2010. Marcel·lí Sugrañes, président de **Rosa Gres**, est l'un des représentants du groupe d'entreprises GBCe en Espagne.

La matière première utilisée pour fabriquer les grilles en bois des piscines provient de zones contrôlées exploitées de manière durable pour favoriser la régénération forestière.







Portada y contraportada / Cover and back cover / Couverture et quatrième de couverture **Hotel Golden Mar Menuda, Tossa de Mar, Spain**

April 2018



**Rosa Gres, S.L.U**

**Oficina Central - Head quarters - Siège Central**

Ctra. Sant Cugat, km. 3

08290 Cerdanyola, Barcelona, Spain

Tel. + 34 93 586 30 60

Fax + 34 93 586 30 61

Ventas: + 34 93 586 37 68 / + 34 93 586 37 69

Export Sales: + 34 93 586 37 02

info@rosagres.com

www.rosagres.com

**Rosa Gres France SARL**

66, Chemin Mirassou

64140 Lons, France

Tel. 04.11.92.00.30

contact@rosagres.com

administration@rosagres.com

www.rosagres.com/fr

**Fábrica - Factory - Usine**

Pol. Ind. Mas Vell

Ramón Sugrañes, 1

43144 Vallmoll, Tarragona, Spain

